

Universal dimming actuator 4gang 20-210W/VA RMD

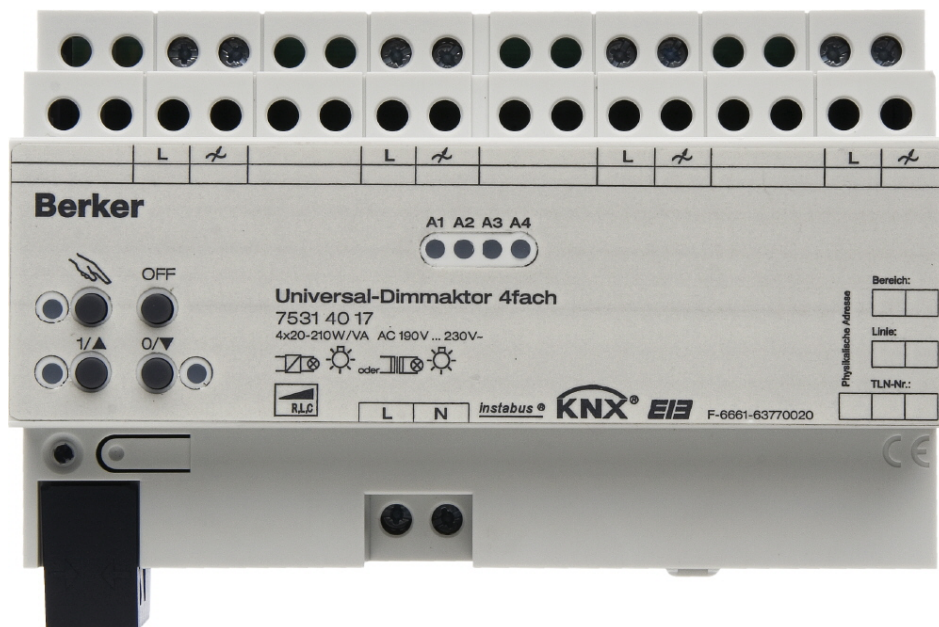

Date of issue: 25.01.2007
64770120.111

Table of Contents

1	<u>Product definition</u>	<u>3</u>
1.1	Product catalogue	3
1.2	Function	3
2	<u>Fitting, electrical connection and operation</u>	<u>4</u>
2.1	Safety instructions	4
2.2	Device components	5
2.3	Fitting and electrical connection	6
2.4	Commissioning	13
2.5	Operation	14
3	<u>Technical data</u>	<u>18</u>
4	<u>Software information</u>	<u>20</u>
4.1	Software specifications	20
4.2	Software "Dimming 301Ax1"	21
4.2.1	Scope of functions	21
4.2.2	Software information	22
4.2.3	Object table	23
4.2.4	Functional description	28
4.2.4.1	Device-independent functional description	28
4.2.4.2	Description of channel-independent functions	32
4.2.4.3	Description of channel-oriented functions	34
4.2.4.4	Delivery state	83
4.2.5	Parameters	84

1 Product definition

1.1 Product catalogue

Product name: Universal dimming actuator 4gang 20-210W/VA RMD
Use: Actuator
Design: REG (rail-mounted device)
Order no.: 7531 40 17

1.2 Function

The universal dimming actuator works on the phase cut-on or cut-off principle and permits switching and dimming of incandescent lamps, HV halogen lamps and LV halogen lamps with conventional and electronic transformers. The device auto-detects the load characteristics of the connected consumer separately for each output and selects the appropriate dimming principle. Alternatively, the dimming principle can also be fixed by means of the corresponding ETS parameters.

The universal dimming actuator permits independent feedback of the individual switching and brightness states of the connected loads by sending the respective telegrams to the KNX/EIB. Moreover, the device can report short-circuits and load failures back to the KNX/EIB separately for each output.

The controls (4 pushbuttons) on the front panel of the device permit switching the dimming outputs on and off by hand in parallel with the KNX / EIB even without bus voltage or in a non-programmed state. This feature permits fast checking of connected consumers for proper functioning.

For project design and start-up of this device it is recommended to use the ETS3.0d. The advantages with regard to downloading (shorter loading times) and parameter programming are available only if this ETS patch version or later versions are used.

The functionalities that can be selected independently for each dimming output include, for instance, separately programmable brightness ranges, enlarged feedback functions, a disabling or, alternatively, a forced-control function, separately presettable dimming behaviour, time delay and Staircase function with pre-warning and soft-dimming functions.

Each output can moreover be integrated into up to 8 scenes with different brightness values.

Centralized switching of all outputs is also available. In addition, the brightness levels of the outputs in case of bus voltage failure or bus voltage return and after an ETS programming operation can be preset separately.

The universal dimming actuator has a power supply connection independent of the load outputs to supply the device electronics and the BCU with power. To permit switching of the outputs, the 230 V mains voltage must always be on. The BCU is additionally supplied from the bus voltage to permit programming with the ETS also in those cases where the mains voltage is not yet connected or switched off. The load outputs have separate phase conductor terminals to supply power to the connected load.

The device is designed for fitting on DIN rails in closed compact boxes or in power distributions in fixed installations in dry rooms.

2 Fitting, electrical connection and operation

2.1 Safety instructions

Electrical equipment must be installed and fitted only by qualified electricians. Observe the current accident prevention regulations.

Failure to observe any of the installation instructions may cause damage to the device and result in fire and other hazards.

The device is not suited for safe disconnection of the mains supply. Shutting off the device does not separate the load electrically from the supply.

Before working on the device or before replacing connected lamps, disconnect the supply voltage (by cutting out the circuit breaker) to avoid the risk of an electric shock.

Disconnect the mains supply also in case of changes to the connected load (e.g. when installing another lighting fixture or when replacing the lamp).

Make sure during the installation that there is always sufficient insulation between mains voltage and bus. A minimum spacing of 4 mm must be ensured between bus wires and mains conductors.

If inductive transformers are used, each transformer must be fuse-protected on the primary side in accordance with the manufacturer's instructions. Use only safety transformers in acc. with DIN EN 61558-2-6 (VDE 0570 Part 2-6)

For extending the load capacity of an output use only suitable power boosters. The selected boosters must be adapted to the dimmer and to the load. Further details are set out in the operating instructions of the corresponding power booster.

Do not open the device and do not operate it outside the scope of the technical specifications.

2.2 Device components

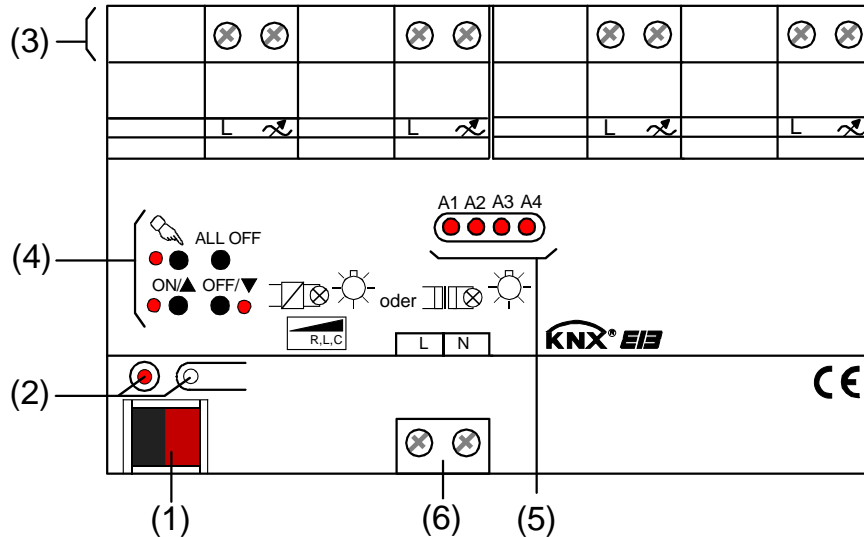

Dimensions:

width (W):
144 mm (8 MW)

height (H):
90 mm

depth (T):
70 mm

- (1): KNX/EIB bus connection
- (2): Programming button and programming LED (red). The programming LED flashes slowly when the safe-state mode is active.
- (3): Screw terminals (L, \sphericalangle) for connection of the load.
- (4): Keypad for manual operation with status LED
- (5): Status LED (red) of the outputs...
 - LED off: output is off,
 - LED on: output is on,
 - LED flashing slowly output operated manually
 - LED flashing fast: output disabled by manual operation
- (6): Screw terminals (L, N) for connection of the mains voltage supply (device supply).

2.3 Fitting and electrical connection

**DANGER!**

Electric shock in case of accidental contact with live parts. Electric shocks can be fatal. Before working on the device, cut out the mains supply and cover up live parts in the surroundings.

Fitting

- Fit the device by snapping it onto a mounting rail in acc. with DIN EN 60715. The screw terminals for connection of the load should be at the top.

 A KNX / EIB data rail is not required.

 Observe the temperature range (-5 °C ...+45 °C) and ensure sufficient cooling.

Connecting the power supply for the device electronics and the load

Observe the admissible load ratings (cf. 'Technical data').

Observe the Technical Operating Conditions of the power supply companies.

Do not exceed the permissible total load including transformer losses (cf. 'Technical data').

Operate inductive transformers with at least 85% of their rated load.

Mixed loads with inductive transformers at an output: Resistive load max. 50%.

Trouble-free operation is ensured only with TRONIC transformers from B-G-J or with inductive iron/copper transformers.

**CAUTION**

Risk of irreparable damage with mixed loads.

Do not connect capacitive loads (e.g. electronic transformers) and inductive loads (e.g. conventional transformers) in common to the same dimming output.

- Connect the mains voltage supply, the loads and the bus line as shown in fig. 1 (wiring example).

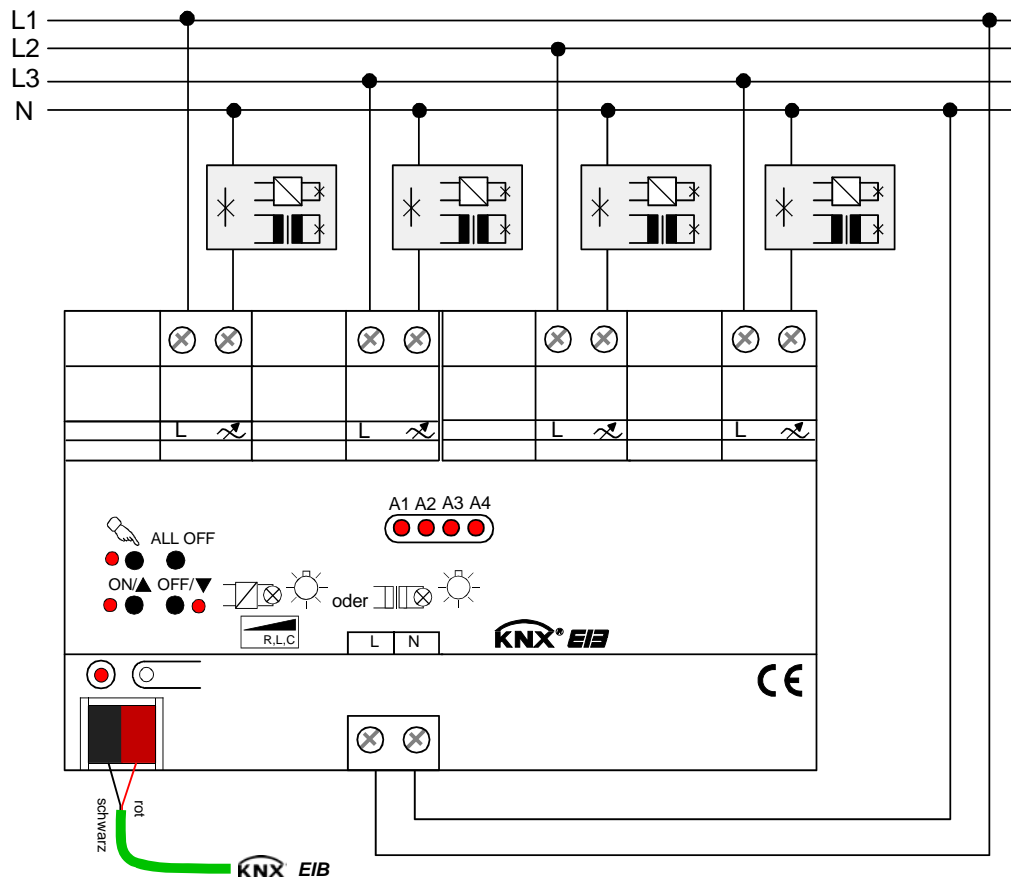

Fig. 1: Electrical connection of mains voltage supply and load

- i** The load outputs and the mains voltage supply of the device (terminals "L") may be connected to different phase conductors (L1, L2, L3).
- i** Telecontrol signals from the power supply companies may cause flickering of the connected lamps. This is not a defect of the device.
- i** When the load capacity of an output is exhausted, the power rating of the actuator can be increased with Berker power boosters. The selected boosters must be adapted to the dimmer and to the load. The information contained in the operating instructions of the corresponding power booster must be observed.
If the load rating of an output is enhanced by universal power boost units, the maximum brightness (ETS parameter) is to be reduced to 90 % max.
- i** If the auto-detection feature of the universal dimming actuator is not used, the dimming principle must be adapted to the connected load in the ETS (ETS parameter). In the state as delivered of the actuator, the automatic detection feature is activated for all outputs.

Changing the type of load connected

When one of the loads connected is changed after initial commissioning – e.g. when a ceiling light fixture with an incandescent lamp is replaced by a low-voltage lighting system with a conventional transformer – it may be the case that with the changing of the load the load type will change as well. If the load type is set to "universal" (ETS parameter), the dimming actuator will in this case try to readapt itself to the new load. For this purpose, the mains voltage supply of the dimming actuator must at first also be shut off.

It is absolutely important that the load type parameterized in the ETS matches the load connected. In case of doubt, the universal dimming principle (with automatic load detection) should be selected.



CAUTION

Risk of irreparable damage if the preselected dimming principle (ETS parameter) and the connected load are not compatible.

Before changing the load type, disconnect the mains supply of the dimming actuator and the load circuit concerned. Check the parameter settings and correct, if needed.

- Disconnect the load circuit from the mains supply (depending on ETS parameterization it may be the case that a load failure telegram will then be transmitted to the bus → see "Load failure detection").
- Disconnect the mains supply of the dimming actuator (terminals "L, N" beside the bus terminal).
- Connect the new load.
- Recommission the device (see chapter 2.4 "Commissioning").

i If the mains voltage supply of the loads and of the actuator are connected to different phase conductors, a multi-pole line circuit breaker is recommended for complete disconnection.

Installing / removing the protective cap

To protect the bus lines against hazardous voltages, especially in the area of the connecting terminals, a protective cap can be installed.

The bus must be connected with the bus line led out at the rear (bus terminal plugged into device).

- To install the cap: Slide the cap over the bus connecting terminal until it is heard to engage (cf. fig. 2.A).
- To remove the cap: Remove the cap by pressing the sides slightly and by pulling it out to the front (cf. fig. 2.B).

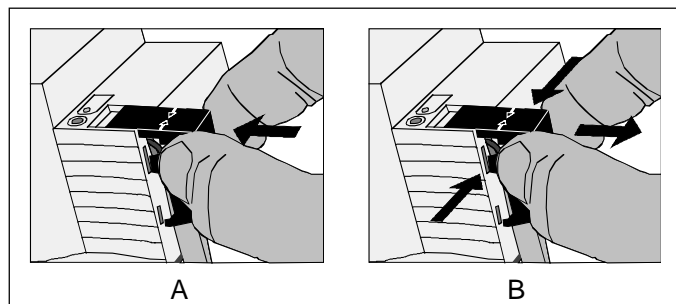

Fig. 2: Installing / removing the protective cap

Load failure detection

The universal dimming actuator can monitor the current circuits of its load outputs independently of one another. The actuator detects mains supply failures (> 15 s) of an output or a circuit interruption when the load is on or off. The load detection function must be separately enabled in the ETS (cf. chapter 4. "Software description").

A load failure caused by an interruption of the load current circuit and which is to be used, for instance, for monitoring a lamp, can be safely detected only in those cases where the load connected to the output interrupts the circuit completely in case of defect. A defective lamp can therefore only be infallibly detected, if ...

- only lamp is connected to the device and if this lamp is defective (e.g. broken filament),
- only one HV halogen lamp is connected to the device and if this lamp is defective,

With other loads or with mixed loads, the detection of a failed lamp is generally not possible. A defective lamp cannot be detected, if...

- LV halogen lamps are connected via conventional or electronic transformers,
- an incandescent lamp is connected in a mixed load configuration together with a conventional or an electronic transformer,
- several incandescent or HV halogen lamps are connected in parallel.

- i** If the load failure detection is enabled in the ETS, the actuator will transmit a message telegram "Load failure detected – 1" to the bus ca. 15 – 20 s after detection of the failure.
- i** A mains voltage failure at an output will always be identified as a load failure, if the mains voltage has failed during more than 15 seconds.
- i** A defective fuse in the primary circuit of a conventional transformer is generally not identified as a load failure.
- i** In the event of a load failure, the actuator sets the switching status to "OFF" and the state of the brightness value to "0" and transmits these values to the bus, if enabled in the ETS.
- i** After an ETS programming operation and after switching on of the bus voltage or of the mains supply, the actuator initializes the "Load failure feedback" objects of all outputs in accordance with their actual state . It should be noted, however, that the "Delay after bus voltage return" parameterized in the ETS must first have elapsed before load failure message telegrams can be transmitted to the bus.

Rectifying a load failure

When the dimming actuator has detected a load failure at an output:

- Disconnect the mains supply of the load circuit concerned.
- Locate the cause of the load failure and rectify.
- Switch the mains supply of the load circuit on again.

The load failure has been reset. After resetting the load failure, the output concerned is deactivated. The output can then again be switched on and off or dimmed as usual.

- i** After removal of the load failure and reactivation of the mains voltage in the load circuit, the actuator will repeat the automatic load detection procedure, if the load type parameter is set to "universal" in the ETS. The load detection procedure is characterized by the lamp flickering twice briefly in case of resistive loads and may last up to 10 seconds depending on power supply conditions.
- i** If the load failure has been rectified, the actuator will send a "no load failure – 0" message telegram to the bus 15 seconds after the reactivation of the mains supply at the earliest. Otherwise, a new load failure message will be transmitted. No message telegram will be sent within the "Delay after bus voltage return".
- i** On deactivation of the mains voltage supply of the dimming actuator (terminals "L" and "N" located beside the bus terminals) the dimming actuator will always – after the "Delay after bus voltage return" parameterized in the ETS – transmit a "no load failure – 0" message telegram to the bus provided the bus voltage is still present. This behaviour is especially important, if the mains voltage supply of the dimming actuator is shut off together with the mains voltage of a load circuit – for instance, when resetting a load failure.

Mains failures

The universal dimming actuator detects mains failures at the load terminals that are caused, for instance, by disturbances in the public low-voltage distribution network.

If a detected mains failure at an output does not last longer than ca. 2 seconds, the dimming actuator reactivates the old brightness value for the outputs concerned and shows no further reaction after return of the mains.

If the mains failure does, however, last longer than ca. 2 seconds, the dimming actuator makes a reset for the outputs concerned when the mains voltage returns. During this reset, the dimming outputs concerned are re-initialized with the ETS parameter values. If the load type is set to "universal" in the ETS. In addition, the actuator will also repeat the automatic load detection procedure. During the initialization after the mains voltage failure, the outputs affected by the mains failure will be shut off. If so parameterized in the ETS, the actuator will then also transmit switching status and value feedback messages to the bus. Thereafter, the outputs can be switched on again as usual. If the mains failure lasts longer than 15 s, a load failure message will moreover be sent to the bus in case the detection function is used (cf. "Load failure detection").

- i** In the event of a 'hard' mains interruption – i.e. one caused, for instance, by disconnecting the mains with a line circuit breaker – the detection time for the mains failure at the load terminals can be as long as 7 seconds (instead of 2 seconds).

If the actuator mains supply fails (terminals "L" and "N" located beside the bus connection), all outputs will always be reset on return of the mains. During this reset, the dimming outputs concerned are re-initialized with the ETS parameter values. If the load types are set to "universal" in the ETS, the actuator will also repeat the automatic load detection procedure. After the initialization (return of the mains), the outputs are set in accordance with the setting of the "Behaviour after bus or mains voltage return" parameter.

Short-circuit and overload detection

Each output of the dimming actuator is equipped with a short-circuit/overload and an over-temperature protection.

In the event of a short-circuit or overloading, the load is disconnected automatically after 7s in the phase cut-off mode (capacitive and resistive loads) and after 100 ms in the phase cut-on mode (inductive loads). After shutting off, the actuator transmits a "short-circuit/overload detected – 1" message telegram for the output concerned to the bus, if this type of message is enabled in the ETS.

When the ambient temperature is too high, the load is shut off by the temperature control of the actuator. After cooling, the outputs concerned are automatically reset by the dimming actuator. During this reset, the dimming outputs concerned are re-initialized with the ETS parameter values. If the load type is set to "universal" in the ETS, the actuator will also repeat the automatic load detection procedure. After the initialization, the outputs concerned will be shut off. If so parameterized in the ETS, the actuator will then also transmit switching status and value feedback messages to the bus.

Thereafter, the outputs can be switched on again as usual. If the over-temperature shutoff lasts longer than 15 s, a load failure message will moreover be reported to the bus in case the detection function is used (cf. "Load failure detection").

Rectifying a short-circuit/overload condition

When the dimming actuator, has detected a short-circuit or an overload condition at one of its outputs, the fault must be rectified and the output reset before the dimming output concerned can be switched on again.

The dimming actuator has detected a short-circuit or an overload at one of the outputs:

- Disconnect the mains supply of the load circuit concerned.
- Shut off the mains supply of the dimming actuator (terminals "L" and "N" located beside the bus terminals).
- Locate the cause of the short-circuit or of the overload and rectify.
- Switch the mains supply of the load circuit on again.
- Switch the mains supply of the dimming actuator on again.

The short-circuit or the overload has been reset. After resetting the short-circuit or the overload condition by reactivating the mains supply of the dimming actuator, the output concerned shows the behaviour parameterized in the ETS under "Behaviour after bus or mains voltage return". The output can then again be switched on and off or dimmed as usual.

- i** After removal of the short-circuit / overload and after reactivation of the mains voltage, the actuator will repeat the automatic load detection procedure, if the load type parameter is set to "universal" in the ETS. The load detection procedure is characterized by the lamp flickering twice briefly in case of resistive loads and may last up to 10 seconds depending on power supply conditions.
- i** 7s after reactivation of the mains supply in the phase cut-off mode and 100 ms after reactivation of the mains supply in the phase cut-on mode, the actuator will transmit a "no short-circuit / no overload – 0" message telegram to the bus, if the short-circuit / the overload has been rectified. Otherwise, a new short-circuit/overload message will be transmitted.
- i** In the event of a short-circuit/overload message, the actuator sets the switching status to "OFF" and the state of the brightness value to "0" and transmits these values to the bus, if enabled in the ETS.

- i** Resetting of a detected short-circuit or overload condition and thus of the message transmitted to the bus can also be effected by switching off the output concerned. The output can be switched off by...
- the object "Switching" = 0,
 - the object "Brightness value" = 0,
 - a scene recall with the brightness value = 0,
 - manual control = OFF.

In the same way, a bus voltage failure with subsequent return of the bus voltage triggers a short-circuit / overload reset.

The reset of a short-circuit / overload message by a simple shutoff can be quite helpful in checking whether the short-circuit or the overload condition is still existing or not. If the reactivation of the output concerned will then produce a new short-circuit / overload fault message, the defect in the system has not yet been rectified.

For safety reasons, it is absolutely indispensable to disconnect the mains supply as described in the working instructions when rectifying short-circuit or overload faults.

- i** After an ETS programming operation and after switching on of the bus voltage or of the mains supply, the actuator initializes the objects "Short-circuit / overload feedback" of all outputs depending on their actual state . It should be noted, however, that the "Delay after bus voltage return" parameterized in the ETS must first have elapsed before short-circuit / overload message telegrams can be transmitted to the bus.
- i** On deactivation of the mains supply of the dimming actuator (terminals "L" and "N" located beside the bus terminals) the dimming actuator will always – after the "Delay after bus voltage return" parameterized in the ETS – transmit a "no short-circuit / no overload – 0" message telegram to the bus provided the bus voltage is still present.

2.4 Commissioning

After installation of the universal dimming actuator and connection of the bus line and the mains supply as well as of all electrical loads, the device can be put into operation. The following procedure is generally recommended...

Putting the device into operation

All loads must have been completely installed and connected.

**DANGER!**

Electric shock in case of accidental contact with live parts. Electric shocks can be fatal. Before working on the device, cut out the mains supply and cover up live parts in the surroundings.

**CAUTION**

Risk of irreparable damage if the preselected dimming principle (ETS parameter) and the connected load are not compatible. Make sure before commissioning that the software settings are compatible with the load.

- Switch on the bus voltage
Check: The red programming LED must light up when the programming button is being depressed.
 - Assign and program the physical address with the help of the ETS.
 - Download the application data with the ETS
 - Switch on the mains supply of the load circuits.
 - Switch on the mains supply of the dimming actuator (terminals "L" and "N").
The universal dimming actuator adapts itself automatically to the loads and selects the suitable dimming procedure, if the load type parameter is set to "universal" in the ETS. The dimming principle can be predefined during parameterization of the device. In this case, the automatic detection procedure is omitted. The actuator sets the brightness at the outputs to the value predefined in the ETS parameter "Behaviour after bus or mains voltage return".
The device is now ready for operation.
- i** The mains supply of the load circuits and the mains supply of the dimming actuator are switched on at the same time, if, for instance, all supplies lines are connected via a line circuit breaker to the same phase conductor. If the load outputs and the mains terminals of the dimming actuator are supplied with power from different phase conductors or via several line circuit breakers, the load circuits should always be switched on before the mains supply of the dimming actuator is switched on. Thus, it can be ensured that the universal dimming actuator can correctly detect the loads connected even in case of great length of cable.
- i** If a short-circuit or an overload is being detected during commissioning at one of the load outputs, the dimming actuator cannot adapt itself to the load. In such case, the fault must first be rectified and the short-circuit or overload condition be reset (cf. "Rectifying a short-circuit/overload condition" above).

2.5 Operation

The universal dimming actuator is equipped with an electronic manual control function for all outputs. The keypad with 4 function keys and 3 status LEDs on the front panel of the device can be used for setting the following modes of operation...

- bus control: operation with touch sensors or other bus devices
- temporary manual control: manual control locally via keypad, automatic return to bus control,
- permanent manual control: local manual control with keypad.

- i** The operating modes can also be disabled by means of parameters in the ETS.
- i** When the manual control mode is active, the outputs cannot be controlled via the bus.
- i** Manual control is possible only while the actuator is supplied with power from the mains. The manual operating mode ends in case of bus voltage return or mains voltage failure.
- i** During bus operation, the manual mode can be disabled by means of a telegram. The manual mode is terminated on activation of the disabling function.
- i** Further details concerning the manual mode, especially with respect to the possible parameter settings and the interaction with other functions of the dimming actuator can be found in chapter 4. "Software description" of the present documentation.

Controls and indicators for manual control

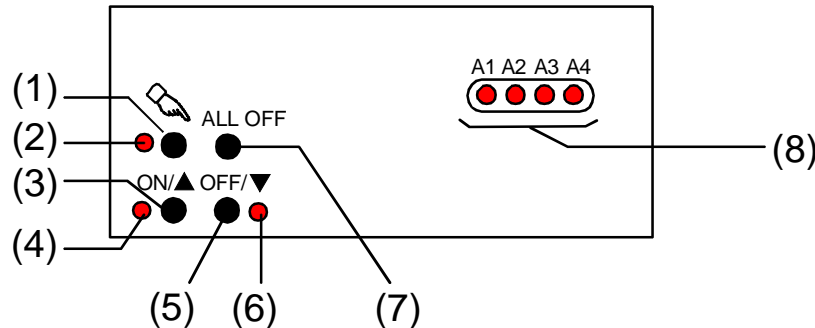

Fig. 3: Controls and indicators for manual control

- (1) Key : activation / deactivation of manual control
- (2) LED : indicates permanent manual control when the LED is ON.
- (3) key ON/▲: brief press: output ON / long press: increase brightness at output.
- (4) Status LED ON/▲: indicates an activated output in the manual control mode when the LED is ON (brightness: 1...100) %).
- (5) Key OFF/▼: brief press: output OFF / long press: reduce brightness at output.
- (6) Status LED OFF/▼: indicates an activated output in the manual control mode when the LED is ON (brightness: 0 %).
- (7) Key ALL OFF
all outputs are switched off if pressed (only in the permanent manual control mode).
- (8) Status LED:
indicate the state of the individual outputs. an LED is on when an output is switched on (brightness: 1...100) %. one of the LEDs flashes, when the corresponding output has been selected with the key in the manual mode.



Priorities

The universal dimming actuator distinguishes between different functions that can be active at an output. In order to prevent conflicting output states, each available function has a certain priority. The function with the higher priority overrides the function with the lower priority.

- 1st priority: Manual control (highest priority)
- 2nd priority: forced-control or disabling function
- 3rd priority: direct bus operation (objects "Switching" & "Dimming" & "Brightness value", scenes, central function)



Activating the temporary manual control

Manual control has been enabled in the ETS.

- Press the  key briefly (< 1 s).
The status LED of output 1 flashes (LED  remains off).
-  After 5 s without key-press, the actuator returns automatically to the bus mode.



Deactivating temporary manual control

The temporary manual control mode has been activated.

- No key-press for 5 s
- or -
- select all outputs one after another by pressing briefly the  key. Thereafter, press the  key once again.
- or -
- shut off the mains supply or make a bus reset (bus voltage return).
The temporary manual control mode is terminated. The state indicator LEDs A1...A4 show the status for bus operation, when the mains voltage is on.
-  During a shutoff of the temporary manual control mode, the brightness state selected in the manual mode does not change. If, however, a forced-control or a disabling function was activated via the bus during the manual mode, the dimming actuator executes the disabling or forced-control functions.



Activating the permanent manual control mode

The manual control mode has been enabled in the ETS. The bus mode or the temporary manual control mode has been activated.

- Press the  key for at least 5 s.
The status LED  is illuminated. The state indicator LED of output 1 is flashing. The permanent manual control mode is now activated.

Deactivating the permanent manual control mode

The permanent manual control mode has been activated:

- Press the  key for at least 5 s.
- or -
- shut off the mains supply or make a bus reset (bus voltage return).
The status LED  goes out. The state indicator LEDs A1...A4 show the status for bus operation, when the mains voltage is on.
-  Depending on the parameterization of the dimming actuator in the ETS, the actuator will either retain the brightness values last set at the outputs (by direct operation, forced-control / disabling function) or show no reaction when the manual control mode is deactivated.

Operating an output in the manual control mode

The manual control mode (permanent or temporary) has been activated.

- Select the desired output: Press the  key briefly (several times, if necessary).
The state indicator LED of the selected output A1...A4 is flashing. The status LED "ON/▲" (1...100 %) or "OFF/▼" (0 %) in the keypad indicate the brightness of the output.
 - Operate the output by pressing the ON/▲ or the OFF/▼ key.
Brief press: Switching on and off.
Long press: increase / reduce the brightness.
Long press & release: stop dimming process.
The selected output executes the corresponding commands immediately.
- i** An output cannot be switched or dimmed in case of a load failure or a short-circuit or when the dimming actuator is busy with the automatic load detection procedure.

Shutting off all outputs

The permanent manual control mode has been activated.

- Press the ALL OFF key.
All outputs shut off immediately (brightness: 0 %). The outputs are not interlocked. They can again be operated individually after shutoff.
- i** The "ALL-OFF" function is not available in the temporary manual control mode.

Disabling the bus control mode for individual outputs by manual operation

The permanent manual control mode has been activated.

Disabling of the bus control mode must have been enabled in the ETS.

- Select an output: Press the  key briefly (several times, if necessary).
The state indicator LED of the selected output A1...A4 is flashing. The status LED "ON/▲" (1...100 %) or "OFF/▼" (0 %) in the keypad indicate the brightness of the output.
 - Press the ON/▲ and the OFF/▼ key at the same time for at least 5 s
The selected output is disabled (the output can no longer be controlled via the bus). The state indicator LED of the selected output A1...A4 is flashing fast.
- i** To unlock, proceed in the same way.
- i** An output that has been disabled manually can thereafter only be operated in the permanent manual mode.
- i** When a disabled output is selected in the manual control mode, the respective status LEDs flashes twice briefly at intervals.

3 Technical data

Type of protection:	IP 20
Safety class:	III
Mark of approval:	KNX / EIB
Ambient temperature:	-5 °C ... +45 °C
Max. housing temperature:	TC = + 75 °C
Storage / transport temperature:	-25 °C ... +70 °C (storage above + 45 °C reduces the lifetime)
Mounting position:	any position (output screw terminals preferably at the top)
Minimum distances:	none
Type of fastening:	Snap-fastening on DIN rail in closed cabinets (e.g. small distributions, etc.) / KNX / EIB data rail not required.
KNX / EIB supply	
Voltage:	21 ... 32 V DC SELV
Power consumption:	typically 150 mW
Connection:	standard KNX/EIB bus connection terminal
External supply	
Voltage:	190 ... 230 V AC +10 % / -15 %, 50/60 Hz
Power consumption:	approx. 1 W (without load at outputs)
Connection:	with screw terminals: 0.5 ... 4 mm ² single wire and stranded wire without ferrule 0,5 ... 2,5 mm ² stranded wire with ferrule Max. tightening torque: 0.8 Nm
Total power loss:	max. 8.5 W (with maximum load at all outputs)
Response to bus voltage failure:	depending on parameterization (cf. chapter 4 "Software description")
Response to mains voltage failure:	All outputs shutting off (cf. chapter 2.3 "Fitting and electrical connection – Mains failures")
Response to bus voltage return:	depending on parameterization (cf. chapter 4 "Software description")
Response to mains voltage return:	All outputs are initialized and, if applicable, redetected (cf. chapter 2.3 "Fitting and electrical connection – Mains failures").

Technical data (continued)

Outputs:

Number:	4 (electronic, MosFETs)
Connection:	with screw terminals: 1.5 ... 4 mm ² single wire and stranded wire without ferrule 1.5 ... 2,5 mm ² stranded wire with ferrule Max. tightening torque: 0.8 Nm
Line length per output:	max. 100 m
Load ratings per output:	
230 V incandescent lamps:	20 ... 210 W
230 V halogen lamps:	20 ... 210 W
LV halogen lamps:	
conventional transformers:	20 ... 210 VA
TRONIC transformers:	20 ... 210 W
Mixed load resistive-inductive:	20 ... 210 W / VA
Mixed load resistive-capacitive:	20 ... 210 W
Mixed load inductive / capacitive:	not permitted
Motor loads	not permitted
Power diagram:	

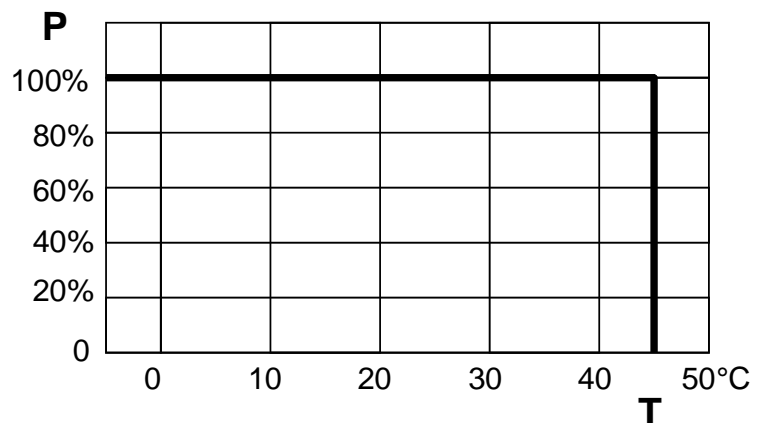

P = output power
T = ambient temperature

Extension of power:

- i When the load capacity of a dimming output is exhausted, the power rating of the actuator can be increased with Berker/Gira/Jung power boosters. The selected boosters must be adapted to the dimmer and to the load. The information contained in the operating instructions of the corresponding power booster must be observed.
If the load rating of an output is enhanced by universal power boost units, the maximum brightness (ETS parameter) is to be reduced to 90 % max.

4 Software information

4.1 Software specifications

ETS search paths: Illumination / dimmer / Universal dimming actuator 4gang 20-210W/VA RMD
BAU used: TPUART + μ C
KNX/EIB type class: 3b - Gerät mit zert. PhL + stack
Configuration: S-mode standard
PEI type "00"_{Hex} / "0"_{Dez}
PEI connector kein Verbinder

Applications:

No.	Summarized description:	Name:	Version:	Executable from mask version:
1	Multi-functional control of up to 4 dimming outputs with presettable dimming behaviour, time functions, scenes, disabling function or forced-control, soft-ON or soft-OFF functions and extended feedback messages. Centralized switching of all outputs is also available. In addition, the brightness levels of the outputs in case of bus voltage failure or bus / mains voltage return and after an ETS programming operation can be preset separately.	Dimming 301A01	0.1 for ETS 2 and ETS 3.0 versions a...c	705
		Dimming 301A11	1.1 for ETS3.0 from version d onwards	

4.2 Software "Dimming 301Ax1"

4.2.1 Scope of functions

General:

- Manual operation of the outputs independent of the bus (site operation possible as well).
- Central function function for common control of all outputs.
- Delay for actively transmitted feedback messages after bus voltage return.

Channel-oriented functions:

- Independent control of up to 4 dimming outputs. Each output offers the full scope of functions without any restrictions. All channel-oriented functions can be parameterized separately for each output. This feature permits independent and multi-functional control of the dimming outputs.
- Switching feedback: active (optionally also cyclical) transmission feedback function to the bus or passive feedback function (by object readout) .
- Selection of load type and thus determination of dimming principle for each output:
 - universal (with automatic load detection procedure),
 - electronic transformer (capacitive / phase cut-off principle),
 - conventional transformer (inductive / phase cut-on principle).
- Presetting of brightness limit values (basic brightness and maximum brightness).
- Dimming behaviour (also fading) and dimming characteristics parameterizable.
- Soft-ON and soft-OFF functions.
- In case of short-circuit / overload and of load failure, message telegrams can be transmitted separately to the bus for each output . A feedback message concerning load type connected is also possible.
- Disabling function or alternatively forced-control function parameterizable for each output. Blinking of connected lamps is possible during the disabling function .
- Timing functions (ON-delay, OFF-delay, staircase lighting timer, also with pre-warning function)
- Operating hours counter independently usable for each output.
- Outputs can be integrated into up to 8 light-scenes:
- Behaviour in case of bus voltage failure and bus voltage return as well as after ETS programming presettable for each output.

4.2.2 Software information

ETS project design and start-up

For project design and start-up of this device it is recommended to use the ETS3.0d. Advantages with regard to downloading (significantly shorter loading times) and parameter programming can be expected only if this ETS patch version or later versions are used. The advantages consist in the use of the new mask version 7.5 and the parameter presentation of the ETS3.

The product database required for the ETS3.0d is offered in the *.VD4 format. The corresponding application program has version number "1.1". For the ETS2 and for older versions of the ETS3, a separate product database in the *.VD2 format is available. The application program for these ETS versions is version number "0.1".

As far as the scope of functions of the parameters described in this documentation is concerned, there is no difference between the two application programs.

When older ETS versions are updated to the level of version ETS3.0d or to that of later versions, an additional tool in the form of an ETS add-in is available. This tool is capable of converting older product databases of application version "0.1", for instance from existing ETS2 project designs, into the new application format (version "1.1"). This feature permits making use of the advantages of the ETS3.0d application in an easy way and without any changes. The ETS3 add-in can be obtained separately from the manufacturer and is free of charge.

Safe-state mode

If the device - for instance as a result of errors in the project design or during start-up - does not work properly, the execution of the loaded application program can be halted by activating the safe-state mode. In the safe-state mode, the outputs cannot be controlled via the bus. The only mode that can be activated is the manual control mode. The actuator remains passive since the application program is not being executed (state-of-execution: terminated). Only the system software is still functional so that the ETS diagnosis functions and also the programming of the device continue to be possible.

Activating the safe-state mode

- Shut off the bus and the mains voltage supply.
- Press the programming button and keep it pressed.
- Switch on the bus or the mains voltage. Release the programming button only after the programming LED starts blinking slowly.

The safe-state mode is activated. With a new brief press on the programming button, the programming mode can be switched on and off as usual also in the safe-state mode. The programming LED will nevertheless continue to blink independently of the programming mode as long as the safe-state mode is active.

- i** The safe-state mode can be terminated by switching off the supply voltage (bus and mains) or by an ETS programming operation.
- i** For activation of the safe-state mode it is not necessary that the bus voltage be on.

Unloading the application program

The application program can be unloaded with the ETS. In this case, the outputs can only be operated manually.

4.2.3 Object table

Number of communication objects:	75
Number of addresses (max):	254
Number of assignments (max):	255
Dynamic table management:	no
Maximum table length:	---

Objects affecting several channels:





Function:	Manual control				
Object	Function	Name	Type	DP type	Flag
 0	Disable	Manual control	1 bit	1.003	C, W, – (R) ¹
Description:	1-bit object for disabling the keys for manual control on the device. The polarity can be parameterized.				

Function:	Manual control				
Object	Function	Name	Type	DP type	Flag
 1	Status	Manual control	1 bit	1.002	C, -, T, R ¹
Description:	1-bit object for manual control status transmission The object is "0", when the manual control mode is deactivated (bus control). The object is "1", when the manual control mode is activated. The user can parameterize whether the temporary or the permanent manual control mode will be indicated as status information or not.				

Function:	Central function				
Object	Function	Name	Type	DP type	Flag
 2	Switching	Central function	1 bit	1.001	C, W, – (R) ¹
Description:	1-bit object for Central function of outputs assigned. The polarity can be parameterized.				

¹ Each communication object can be read out. For reading, the R-flag must be set.

Channel-oriented objects:

Function: Output switching						
Object	Function	Name	Type	DP type	Flag	
 3, 21, 39, 57	Switching	Output 1 ... 4	1 bit	1.001	C, W, – (R) ¹	
Description: 1-bit object for switching an output on and off ("1" = switching on / "0" = switching off).						
Function: Output relative dimming						
Object	Function	Name	Type	DP type	Flag	
 6, 24, 42, 60	Dimming	Output 1 ... 4	4 bit	3.007	C, W, – (R) ¹	
Description: 4-bit object for relative dimming of an output.						
Function: Output absolute dimming						
Object	Function	Name	Type	DP type	Flag	
 7, 25, 43, 61	Brightness value	Output 1 ... 4	1 byte	5.001	C, W, – (R) ¹	
Description: 1-byte object for presetting an absolute dimming value (brightness value 0...255) from the bus.						
Function: Switching feedback						
Object	Function	Name	Type	DP type	Flag	
 8, 26, 44, 62	Switching feedback	Output 1 ... 4	1 bit	1.001	C, -, T, R ^{1 2}	
Description: 1-bit object for reporting the switching status ("1" = on / "0" = off) back to the bus.						
Function: Feedback absolute dimming						
Object	Function	Name	Type	DP type	Flag	
 9, 27, 45, 63	Brightness value feedback	Output 1 ... 4	1 byte	5.001	C, -, T, R ^{1 2}	
Description: 1-byte object for reporting a preset dimming value (brightness value 0...255) back to the bus.						

¹ Each communication object can be read out. For reading, the R-flag must be set.

² Depending on parameterization, feedback objects are either actively transmitting (T-flag set) or passively readable (R-flag set).

Function: Staircase function

Object	Function	Name	Type	DP type	Flag
 4, 22, 40, 58	Staircase timer start / stop	Output 1 ... 4	1 bit	1.010	C, W, - (R) ¹

Description: 1-bit object for activation or deactivation of the ON-time of the Staircase function of an output ("1" = on / "0" = off).

Function: Staircase function

Object	Function	Name	Type	DP type	Flag
 5, 23, 41, 59	Staircase function factor	Output 1 – 4	1 byte	5.010	C,W, -, (R) ¹

Description: 1-byte object for setting the time factor for the lighting time of the staircase timer function (value range: 0 ... 255).

Function: Disabling function

Object	Function	Name	Type	DP type	Flag
 10, 28, 46, 64	Disable	Output 1 ... 4	1 bit	1.003	C, W, - (R) ¹

Description: 1-bit object for disabling of an output (polarity parameterizable).

Function: Forced-control function

Object	Function	Name	Type	DP type	Flag
 11, 29, 47, 65	Forced-control position	Output 1 ... 4	2 bit	2.001	C, W, - (R) ¹

Description: 2-bit object for the forced-control of an output. The polarity is predefined by the telegram.

Function: Scenes

Object	Function	Name	Type	DP type	Flag
 12, 30, 48, 66	Scene extension	Output 1 ... 4	1 byte	18.001	C, W, - (R) ¹

Description: 1-byte object for recalling scenes or for storing new scene values.

Function: Short-circuit and overload monitoring

Object	Function	Name	Type	DP type	Flag
 14, 32, 50, 68	Short-circuit / overload feedback	Output 1 ... 4	1 bit	1.005	C, -, T, R ¹

Description: 1-bit object for signalling a short-circuit or an overload at an output ("1" = short-circuit / overload / "0" = no short-circuit / overload).

¹ Each communication object can be read out. For reading, the R-flag must be set.

Function: Load failure monitoring

Object	Function	Name	Type	DP type	Flag
 15, 33, 51, 69	Load failure feedback	Output 1 ... 4	1 bit	1.005	C, -, T, R ¹

Description: 1-bit object for signalling a load failure at an output ("1" = load failure / "0" = no load failure).

Function: Operating hours counter

Object	Function	Name	Type	DP type	Flag
 16, 34, 52, 70	Limit / start value ³ operating hours counter	Output 1 ... 4	2 byte	7.007	C, W, - (R) ¹

Description: 2-byte object for external preset of a limit / start value for the operating hours counter of an output. Value range: 0 ... 65535

Function: Operating hours counter

Object	Function	Name	Type	DP type	Flag
 17, 35, 53, 71	New start operating hours counter	Output 1 ... 4	1 bit	1.015	C, W, - (R) ¹

Description: 1-bit object for resetting the operating hours counter of an output ("1" = restart, "0" = no reaction).

Function: Operating hours counter

Object	Function	Name	Type	DP type	Flag
 18, 36, 54, 72	Value operating hours counter	Output 1 ... 4	2 byte	7.007	C, -, T, R ¹

Description: 2-byte object for transmission or readout of the current count of the operating hours counter. The value of the communication object is not lost after a bus voltage failure and is actively transmitted to the bus after bus voltage return or after programming with the ETS. In the as-supplied state, this value is "0".

¹ Each communication object can be read out. For reading, the R-flag must be set.

³ Limit value object or start value object depending on type of counter programmed as operating hours counter.

Function: Operating hours counter

Object	Function	Name	Type	DP type	Flag
 19, 37, 55, 73	Runout operating hours counter	Output 1 ... 4	1 bit	1.002	C, -, T, R ¹

Description: 1-bit object for signalling that the operating hours counter has run out (up-counter = limit value reached / down-counter = value "0" reached). In case of feedback, the object value is transmitted actively to the bus ("1" = message active / "0" = message inactive). The value of the communication object is not lost after a bus voltage failure and is actively transmitted to the bus after bus voltage return or after programming with the ETS.

Function: Load type feedback

Object	Function	Name	Type	DP type	Flag
 20, 38, 56, 74	Load type feedback	Output 1 ... 4	1 byte	20.xxx	C, -, T, R ¹

Description: 1-byte object for signalling the preset load type of an output.
 "0" = undefined (no automatic load detection: no mains voltage / short-circuit),
 "1" = capacitive (preset via parameter),
 "2" = inductive (preset via parameter),
 "3" = universal, automatic adaptation to capacitive or resistive load,
 "4" = universal, automatic adaptation to inductive load,
 "5 ... 255" not used.

¹ Each communication object can be read out. For reading, the R-flag must be set.

4.2.4 Functional description

4.2.4.1 Device-independent functional description

Manual control

The universal dimming actuator is equipped with an electronic manual control function for all outputs. The keypad with 4 function keys and 3 status LEDs on the front panel of the device can be used for setting the following modes of operation...

- Bus control mode: operation with touch sensors or other bus devices
- Temporary manual control mode: manual operation locally via keypad, automatic return to bus control,
- Permanent manual control mode: local manual operation with keypad.

The operation of the function keys, the control of the outputs and the status indication are described in detail in chapter "2.5. Operation".

The following paragraphs are to give a more detailed description about the parameterization, status feedback, disabling via bus control and interaction with other functions of the dimming actuator in the case of activation and deactivation of the manual control mode.

Manual operation is only possible when the actuator is supplied with power from the mains. In the as-supplied state of the actuator the manual control mode is fully enabled. In this unprogrammed state, all outputs can be operated manually so that fast function checking of the connected drives (e.g. on the construction site) is possible.

After the first start-up of the actuator with the ETS, the manual control mode can be separately enabled or disabled for different states of operation. Manual operation can, for instance, be disabled when the device is in the bus mode (bus voltage applied). Another option consists in the complete disabling of the manual control mode only in case of bus voltage failure. This means that manual operation can be completely disabled not only during the bus mode, but also only in case of bus failures.

Enabling the manual control mode

Manual control for the different states of operation is enabled or disabled by means of the parameters "Manual control in case of bus voltage failure" and "Manual control during bus mode".

- Set the parameter "Manual control in case of bus voltage failure" to "enabled".
Manual control is then basically enabled when the bus voltage is off. This setting corresponds to the setting of the actuator as supplied.
- Set the parameter "Manual control in case of bus voltage failure" to "disabled".
Manual control is completely disabled when the bus voltage is off. In this case, operation via the bus is not possible either so that the outputs of the actuator can no longer be actuated.
- Set the parameter "Manual control during bus mode" to "enabled".
Manual control is then basically enabled when the bus voltage is on. The outputs of the actuator can be operated via the bus or manually. This setting corresponds to the setting of the actuator as supplied.

- Set the parameter "Manual control during bus mode" to "disabled".
Manual control is completely disabled when the bus voltage is on. In this configuration, the actuator outputs can only be operated via the bus.
- ❗ An active manual control mode will not be terminated when the bus voltage fails, even if the parameter "Manual control in case of bus voltage failure" is set to "disabled". The manual mode will be disabled only after it has been terminated.
- ❗ Further parameters and communication objects of the manual control are visible only if the parameter "Manual control during bus mode" is set to "enabled". For this reason, disabling function, status message and bus control disable can only be configured if the parameter is set as above.

Presetting the behaviour at the beginning and at the end of manual control mode

The manual control mode is divided into the temporary and the permanent manual control mode. Depending on these modes, the actuator behaves differently, especially at the end of the control mode. It should be noted that the operation via the bus, i.e. control of the outputs by direct operation (switching / dimming / brightness value / scenes / central) or by the disabling or forced-control functions is always disabled while the manual control mode is active. This is to say that the manual control mode has the highest priority.

Behaviour at the beginning of manual control:

There is no difference between temporary or permanent manual control as far as the behaviour at the beginning of manual control is concerned. The activation of the manual control mode leaves the brightness levels unchanged.

Special case: flash mode with disabling function: Lamp flashing in a disabling function will be interrupted at the beginning of manual control. The brightness is switched to the brightness after switching on. The switching status is indicated as "ON".

Active Forced-control position or disabling functions can be overridden by the manual control mode. These functions are reactivated after deactivation of the manual mode unless they have not been cancelled via the bus.

Behaviour at the end of the manual control mode:

The behaviour at the end of manual control differs between temporary and permanent manual control. The temporary manual mode is shut off automatically when the last output has been selected and when the selection key \mathcal{Q} is pressed once again. During a shutoff of the temporary manual control mode, the dimming actuator goes back to 'normal' bus operation and does not change the brightness levels selected by manual operation. If, however, a Forced-control position or a disabling function was activated via the bus before or during the manual mode, the dimming actuator executes these higher-ranking functions for the outputs concerned.

The permanent manual control mode is shut off, when the selection key \mathcal{Q} is pressed for more than 5 s. Depending on the parameterization of the actuator in the ETS, the outputs will be set to the state last adjusted in the manual mode or to the state internally retained (direct operation, forced-control, disabling) when the permanent manual mode is shut off. The parameter "Behaviour at the end of permanent manual control during bus mode" defines the corresponding reaction.

- Set the parameter "Behaviour at the end of permanent manual control during bus mode" to "no change".

All telegrams received during an active permanent manual control mode for direct operation (switching, dimming, brightness value, central, scenes) will be rejected. After the end of the permanent manual control mode, the current brightness level of all outputs remains unchanged. If, however, a Forced-control position or a disabling function was activated via the bus before or during the manual mode, the dimming actuator executes these higher-ranking functions for the outputs concerned.
- Set the parameter "Behaviour at the end of permanent manual control during bus mode" to "track outputs".

During an active permanent manual control all incoming telegrams are internally tracked. At the end of manual control, the outputs are set to the brightness levels last tracked. If, however, a Forced-control position or a disabling function was activated via the bus before or during the manual mode, the dimming actuator executes these higher-ranking functions for the outputs concerned.
- ❗ The behaviour at the end of the permanent manual control when the bus voltage is off (only manual control) is permanently set to "no change".
- ❗ The control operations triggered in the manual control mode will be transmitted via feedback objects to the bus, if enabled and if actively transmitting.
- ❗ On return of bus voltage or after programming with the ETS an activated manual control mode will always be terminated. In this case, the parameterized or predefined behaviour at the end of manual control will not be executed. The dimming actuator executes the behaviour parameterized for the event of bus/mains voltage return or after an ETS programming operation.

Presetting the manual control mode disabling function

The manual control mode can be separately disabled via the bus, even if it is already active. As soon as a disabling telegram is received via the disabling object when the disabling function is enabled, the actuator terminates an activated manual control mode immediately and locks the function keys on the device panel. The telegram polarity of the disabling object is parameterizable.

The manual control mode during bus operation must have been enabled.

- Set the parameter "Disable function for manual control?" on parameter page "Manual control" to "yes".

The manual control mode disabling function is enabled and the disabling object is visible.
- Select the desired telegram polarity in the "Polarity of disable object for manual control" parameter.
- ❗ If the polarity is "0 = disabled; 1 = enabled", the disabling function is active immediately on return of bus/mains voltage or after an ETS programming operation (object value "0"). To activate the manual control in this case, an enable telegram "1" must first be sent to the disabling object.
- ❗ In case of bus voltage failure, disabling via the disabling object is always inactive (depending on parameterization, the manual control is then either enabled or completely disabled). After return of bus voltage, a disabling function that was active beforehand is always inactive in case of non-inverted polarity of the disabling object.

- i** In case of a mains supply failure (no mains voltage at terminals "L" and "N"), disabling via the disabling object will be deactivated in case of non-inverted polarity.
- i** When an active manual control is terminated by a disable, the actuator will also transmit a "Manual control inactive" status telegram to the bus, if the status messaging function is enabled.

Presetting the status messaging function for the manual control mode

The dimming actuator can transmit a status message to the bus via a separate object, when the manual control mode is being activated or deactivated. The status telegram can only be transmitted when the bus voltage is on. The polarity of the status telegram can be parameterized.

The manual control mode during bus operation must have been enabled.

- Set the parameter "Transmit manual control status?" on the "Manual control" parameter page to "yes".

The status messaging function of the manual mode is enabled and the status object is visible.

- Specify in the "Function and polarity of status object" parameter whether the status telegram is generally a "1" telegram whenever the manual control mode is activated or only in those cases where the permanent manual mode is activated.

- i** The status object is always "0", when the manual control mode is deactivated.
- i** The status will be actively transmitted to the bus ("0") only if a manual control that was activated during bus voltage failure is terminated by the return of the bus voltage. The status telegram is in this case transmitted without delay.
- i** When an active manual control is terminated by a disable, the actuator will also transmit a "Manual control inactive" status telegram to the bus.

Presetting the bus control disabling function

Individual dimming outputs can be disabled locally so that the connected consumers no longer be controlled via the KNX/EIB. A bus control disable is effected by local operation in the permanent manual mode and indicated by the rapidly flashing status LED on the front panel of the device. The disabled outputs can then only be actuated in the permanent manual control mode.

The manual control mode during bus operation must have been enabled.

- Set the parameter "Bus mode of individual groups can be disabled?" on the "Manual control" parameter page to "yes".

The bus control disabling function is enabled and can be activated locally. If the alternative setting "no" is selected for this parameter, the activation of bus control disable in the permanent manual mode is not possible.

- i** A locally activated disable has the highest priority. Other functions of the actuator that can be activated via the bus (e.g. Forced-control position or disabling function) are then overridden. Depending on the parameterization of the actuator in the ETS, the groups will be set to the state last adjusted in the manual mode or to the state internally tracked (direct operation, forced-control, disabling function lock) when the disabling function is released and the permanent manual mode shut off thereafter.
- i** A locally activated bus control disable will not be reset in case of bus voltage failure or bus voltage return. A supply voltage failure (mains voltage failure) or an ETS programming operation will always deactivate the bus control disable.

4.2.4.2 Description of channel-independent functions

Delay after bus / mains voltage return

To reduce telegram traffic on the bus line after activation of the bus voltage (bus reset) or also of the mains voltage, after connection of the device to the bus line or after programming with the ETS, it is possible to delay all actively transmitted feedback telegrams of the actuator. For this purpose, a channel-independent delay can be specified (parameter "Delay after bus voltage return" on parameter page "General". Feedback telegrams for bus initialization will therefore be transmitted to the bus only after the parameterized time has elapsed.

Which of the channel-independent feedback telegrams is actually delayed and which is not can be specified for each dimming output channel and for each feedback function separately.

- i** The delay has no effect on the behaviour of the individual output. Only the feedback telegrams are delayed. The outputs can also be activated during the delay after bus voltage return.
- i** A setting of "0" for the delay after bus voltage return deactivates the delaying function altogether. In this case, all feedback telegrams, if actively transmitted, will be transmitted to the bus without any delay.
- i** All actively transmitting objects of the operating hours counters or the signalling objects "load failure", "short-circuit / overload" and "load type" are considered as feedback objects. In this case, however, all feedback telegrams are always transmitted with a delay depending on the parameter selected under "Delay after bus voltage return".
- i** After return of the bus voltage, the message "manual control status" will be actively transmitted to the bus ("0") only if a manual control that was activated during bus voltage failure is terminated by the return of the bus voltage. In this case, the status telegram is always transmitted without delay.
- i** Due to system constraints, there will always be a short delay after an ETS programming operation even if the parameter "Delay after bus voltage return" is set to "0".
- i** Even after actuator supply voltage failure (terminals "L" and "N"), telegrams will still be transmitted to the bus, if the bus voltage is still on. In case of a mains voltage failure, the feedback telegrams are transmitted with after the delay parameterized in the ETS.

Presetting a feedback delay

Only those feedbacks that are enabled and preset as actively transmitting ones can be parameterized with regard to the transmission behaviour after bus voltage return.

- Set the parameter "Time delay for feedback telegram after bus voltage return?" to "yes". This parameter is listed on the parameter page of the corresponding switching status or brightness value feedback for an output.

In this case, the feedback telegram will only be transmitted at the end of the delay after bus / mains voltage return. As an alternative (setting "no"), the feedback telegram can be transmitted to the bus without any delay.

Central function

The actuator offers the possibility of linking selected individual or all outputs with a 1-bit central communication object. The behaviour in case of activating an output via the central function is comparable to a central group address linked with all "Switching" objects.

The outputs assigned to the central function are activated in accordance with the central object value received. The polarity of the central telegram can be inverted in the corresponding parameter.

The behaviour of the outputs is identical with the 'normal' activation via the "Switching" objects (same priority – last switching command is executed – cf. fig. 4). Thus, all 'secondary' functions such as timing or additional functions are included as well.

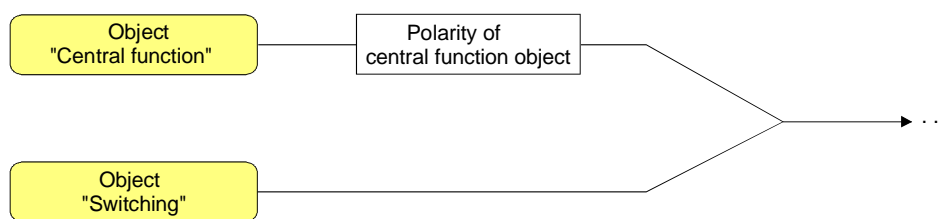

Fig. 4: Functional diagram "Centralized switching"

Enabling the central function

- Enable the central function on parameter page "General" by setting the "Central function ?" parameter to "yes".

When the function is activated, the "Central function" communication object is visible.

Assigning outputs to the central function

Each dimming output can be assigned independently to the central function.

The central function must have been enabled on parameter page "General". The assignment has otherwise no effect on the output.

- Set the "Assignment to the central function?" parameter on the "Ax-General" page (x = number of output) to "yes".

The corresponding output is now assigned to the central function. The connected consumers can be switched on or off from a centrally.

- i** The switching state set by the central function is tracked in the feedback objects and also transmitted to the bus, if these objects are actively transmitting objects. The switching state set by a central function is not tracked in the "Switching" objects.
- i** After a bus / mains voltage return or after programming with the ETS, the central function is always deactivated (object value "0").

4.2.4.3 Description of channel-oriented functions

Definition of load type and load type feedback

The universal dimming actuator works on the phase cut-on or cut-off principle and permits switching and dimming of incandescent lamps, HV halogen lamps and LV halogen lamps with conventional and electronic transformers. The device automatically detects the load characteristics of the connected consumer separately for each output and selects the appropriate dimming principle. Alternatively, the dimming principle can also be preset by means of a parameter in the ETS without automatic detection.

Defining the load type

The parameter "Type of connected load" on parameter page "Ax – General" (x = number of output 1...4) defines the dimming procedure for each of the dimming outputs.

**CAUTION**

Risk of irreparable damage if the preselected dimming principle (ETS parameter) and the connected load are not compatible.

Before changing the load type, disconnect the mains supply of the dimming actuator and the load circuit concerned. Check the parameter settings and correct, if needed.

**CAUTION**

Risk of irreparable damage with mixed loads.

Do not connect capacitive loads (e.g. electronic transformers) together with inductive loads (e.g. conventional transformers) to the same dimming output.

- Set the parameter to "universal" (with automatic detection)".
The dimming output can be adapted to all types of loads. After an ETS programming operation, after switching on of the mains supply of the actuator (terminals "L" and "N") or after switching on of the mains supply of a load output, the actuator performs the automatic detection procedure and adapts itself to the connected load. The load detection procedure is characterized by the lamp flickering twice briefly in case of resistive loads and may last up to 10 seconds depending on power supply conditions.
 - Set the parameter to "electronic transformer (capacitive / phase cut-off)".
The dimming output is permanently set to the phase cut-off principle. The automatic load detection is omitted. The output can be connected to resistive loads or to electronic transformers.
 - Set the parameter to "conventional transformer (inductive / phase cut-on)".
The dimming output is permanently set to the phase cut-on principle. The automatic load detection is omitted. The output can be connected to conventional transformers.
- i** In the as-supplied state of the actuator, the dimming principle is set to "universal" for all outputs.
- i** When the type of load connected to an output is changed, it may be the case that the dimming principle must be changed, too. The procedure required for changing the load type is described in chapter 2.3 "Fitting and electrical connection".

Enabling load type feedback

The universal dimming actuator has a load type feedback function permitting to report the preset or automatically determined load type back to the bus. This feature allows to identify the dimming principle used by the output without having to know the ETS parameter settings. In the universal mode it is moreover possible to determine whether the dimming output works with the phase cut-on or with the phase cut-off principle.

The load type is reported back via the 1-byte object "Load type feedback" existing for each output. The object value is coded as shown in table 1.

Object value	Meaning
0	load type undefined (mains voltage failing, short-circuit, etc. / automatic load detection not possible)
1	load type capacitive / resistive (preset in ETS parameter)
3	load type inductive (preset in ETS parameter)
4	load type universal, capacitive or resistive load successfully detected
5 ... 255	load type universal, inductive load successfully detected
	not used

Table 1: Value code of "Load type feedback" object

- Set the parameter "Load type feedback ?" on parameter page "Ax - Enabled functions" (x = number of output 1...4) to "yes".

The load type feedback function is now enabled and active. A feedback telegram is actively transmitted to the bus after return of the bus or the mains voltage, in case of a mains voltage failure (with value "0") and after an ETS programming operation. If the load type is set to "universal", a telegram is moreover transmitted whenever an automatic re-detection procedure is performed (e.g. after load failure or short-circuit / overload).

- ⓘ It should be noted, however, that after an ETS programming operation and after switch-on of the bus voltage or of the mains supply of the actuator, the "Delay after bus voltage return" parameterized in the ETS must first have elapsed before a load type message telegram can be transmitted to the bus.

Short-circuit / overload feedback

Each output of the dimming actuator is equipped with a short-circuit/overload protection. In the event of a short-circuit or overloading, the load is disconnected automatically after 7s in the phase cut-off mode (capacitive and resistive loads) and after 100 ms in the phase cut-on mode (inductive loads). For the outputs concerned, the actuator can transmit a "short-circuit/overload" feedback telegram to the bus after shut-off, if feedback is enabled in the ETS.

The following instructions describe how to enable a short-circuit/overload feedback message and how such message is transmitted by means of a telegram.

The rectification of a short-circuit or overload fault is described in detail in chapter 2.3 "Fitting and electrical connection".

Enabling short-circuit / overload feedback telegrams

A short-circuit or an overload condition is reported back via the 1-bit "Short-circuit / overload feedback" object existing for each output. The object can be enabled with the parameter "Short-circuit / overload feedback ?" on parameter page "Ax – Enabled functions (x = number of output 1...4).

- Set the parameter to "yes".

The short-circuit/overload feedback function is enabled and active. After identification of a short-circuit, the actuator transmits a feedback telegram "short-circuit / overload detected – 1" to the bus.

- ❗ In the event of a short-circuit/overload message, the actuator sets the switching status to "OFF" and the state of the brightness value to "0" and transmits these values to the bus, if enabled in the ETS.
- ❗ 7s after reactivation of the mains supply in the phase cut-off mode and 100 ms after reactivation of the mains supply in the phase cut-on mode, the actuator transmits a "no short-circuit / no overload – 0" message telegram to the bus, if the short-circuit / the overload has been rectified. Otherwise, a new short-circuit/overload message will be transmitted.
- ❗ After an ETS programming operation and after switching on of the bus voltage or of the mains supply, the actuator initializes the objects "short-circuit / overload feedback" of all outputs depending on their current state. It should be noted, however, that the "Delay after bus voltage return" parameterized in the ETS must first have elapsed before short-circuit / overload message telegrams can be transmitted to the bus.

Load failure feedback

The universal dimming actuator can monitor the current circuits of its load outputs independently of one another. The actuator detects mains supply failures (> 15 s) of an output or a circuit interruption when the load is on or off. The load failure detection can be enabled separately for each output in the ETS.

The following instructions describe how to enable a load failure detection feedback message and how such message is transmitted by means of a telegram.

The events causing a load failure and the rectification of these faults are described in detail in chapter 2.3 "Fitting and electrical connection".

Enabling load failure feedback telegrams

A load failure is reported back via the 1-bit "Load failure feedback" object existing for each output. The object can be enabled with the parameter "Load failure feedback ?" on parameter page "Ax – Enabled functions (x = number of output 1...4).

- Set the parameter to "yes".

The load failure feedback function is now enabled and active. After identification of a load failure, the actuator transmits a feedback telegram "load failure detected – 1" to the bus. A mains voltage failure at an output will always be identified as a load failure, if the mains voltage has failed during more than 15 seconds.

- ❗ In the event of a load failure, the actuator sets the switching status to "OFF" and the state of the brightness value to "0" and transmits these values to the bus, if enabled in the ETS.
- ❗ After an ETS programming operation and after switching on of the bus voltage or of the mains supply, the actuator initializes the objects "Load failure feedback" of all outputs depending on their actual state. It should be noted, however, that the "Delay after bus voltage return" parameterized in the ETS must first have elapsed before load failure message telegrams can be transmitted to the bus.
- ❗ If the load failure has been rectified, the actuator will send a "no load failure – 0" message telegram to the bus 15 seconds after the reactivation of the mains supply at the earliest. Otherwise, a new load failure message will be transmitted.
- ❗ On deactivation of the mains voltage supply of the dimming actuator (terminals "L" and "N" located beside the bus terminals) the dimming actuator will always – after the "Delay after bus voltage return" parameterized in the ETS – transmit a "no load failure – 0" message telegram to the bus provided the bus voltage is still present. This behaviour is especially important, if the mains voltage supply of the dimming actuator is shut off together with the mains voltage of a load circuit – for instance, when resetting a load failure.

Definition of brightness range

The brightness adjusting range of a dimming output can be limited by defining a basic brightness and an upper limit brightness. The parameters "Basic brightness" and "Maximum brightness" on parameter page "Ax – General" (x = number of output 1...4) are used to fix the lower and upper brightness thresholds which are not exceeded in any active state of operation of the output. The brightness of the connected lamps can thus be individually adapted to the subjective sensation of brightness of the human eye. A brightness level below the programmed basic brightness is not possible except by switching off.

In addition, the brightness to be adjusted after each switch-on via the "Switching" or the "Central function" object can be preset. This switch-on brightness is defined separately for each output with the parameter "Switch-on brightness" on parameter page "Ax – General" (x = number of output 1...4). The adjustable value lies between the basic brightness and the maximum brightness (cf. fig. 5).

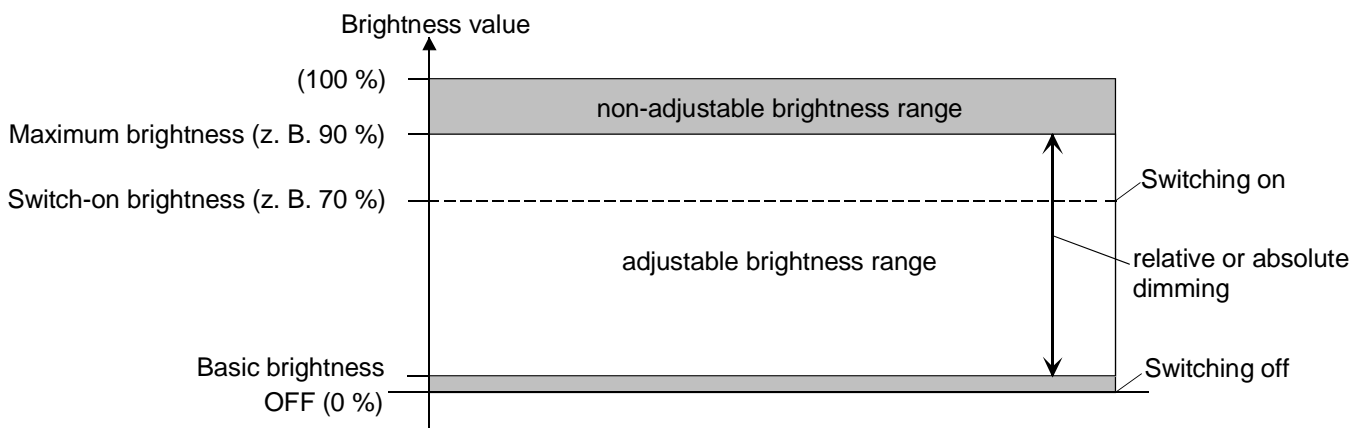

Fig. 5: Example of a brightness range with switch-on brightness for a dimming output

Presetting the basic brightness

The basic brightness can be set separately for each dimming output.

- Set the parameter "Basic brightness" on parameter page "Ax – General" (x = number of output 1...4) to the desired brightness level.

The adjusted brightness level is then equal to brightness value = "1" and is thus the lowest possible limit in all active states of operation of the output.

- ⓘ The basic brightness is always related to the absolute brightness value "1". The corresponding parameter defines the lowest setting required for the lamps used to reach this brightness value. The parameter should be adjusted in such a way that the lamp is just lit up in the lowest dimming position.

Presetting the maximum brightness

The maximum brightness can be set separately for each dimming output.

- Set the parameter "Maximum brightness" on parameter page "Ax – General" (x = number of output 1...4) to the desired brightness level.

The adjusted brightness cannot be exceeded in any of the active states of operation of the output.

- ⓘ The ETS does NOT check all brightness settings of an output (e.g. switch-on brightness, scene values, etc.) when editing the maximum brightness. If individual brightness values in the configuration of an output exceed the parameterized maximum brightness, the actuator will adjust the output in operation to the maximum brightness value.
- ⓘ If values exceeding the parameterized maximum brightness are received via the brightness value object, the dimming actuator adjusts the output concerned to the maximum brightness value.
- ⓘ If the load rating of an output is enhanced by universal power boost units, the maximum brightness is to be reduced to a maximum of 90 %.

Presetting the switch-on brightness

The switch-on brightness can be set separately for each dimming output.

- Set the parameter "Switch-on brightness" on parameter page "Ax – General" (x = number of output 1...4) to "basic brightness" or to another brightness level (in %).

The output is adjusted to the preset brightness on reception of an ON telegram via the "Switching" communication object. The output is moreover adjusted to the parameterized switch-on brightness when a central telegram with the polarity "activated" is being received.

- As an alternative, the parameter "Switch-on brightness" can be set to "memory value (brightness prior to the last shut-off)"

After switch-on, the output is adjusted to the brightness value that was active and internally stored before the last shut-off (via the "Switching" or the "Central function" object. This memory value is stored non-permanently so that after a mains voltage failure in the actuator or after an ETS programming operation the brightness is set to maximum. A bus voltage failure alone is not sufficient to erase the memory value.

- ⓘ If the parameterized switch-on brightness exceeds the parameterized maximum brightness, the dimming actuator adjusts the output concerned to the maximum brightness value as the new value when switching on.
- ⓘ A memory value will be internally stored after a shut-off telegram even in those cases where the bus-controlled shut-off is overridden, for instance, by a disabling or by a forced-control function or by a manual control operation. In this case, the value stored as memory value is the internally tracked brightness value.
- ⓘ If no soft-ON function is active, the actuator adopts the brightness value after switch-on by instantaneous approach. When a soft-ON function is active, the actuator approaches the switch-on brightness gradually with the speed programmed for the soft-ON function.
- ⓘ When a dimming output is switched on by manual control it is always switched on with the maximum brightness. In this case, the "Switch-on brightness" parameter has no effect.

Behaviour in case of bus voltage failure, after bus or mains voltage return or after an ETS programming operation

The switching states or brightness values of the outputs after bus voltage failure, bus or mains voltage return or after an ETS programming operation can be preset separately.

Presetting the behaviour after an ETS programming operation

The parameter "Behaviour after ETS programming" exists separately for each output on the parameter page "Ax - General" (x = number of output 1...4). This parameter can be used to define the brightness behaviour of an output independent of the behaviour after bus or mains voltage return.

- Set the parameter to "no reaction".
After an ETS programming operation, the output shows no reaction and remains at the currently adjusted brightness level or off.
 - Set the parameter to "0 % (shut-off)".
The output is shut off after an ETS programming operation.
 - Set the parameter to "basic brightness" or to another brightness value (in %).
The output is adjusted to the preset brightness value. It must be ensured that the parameterized value does not exceed the preset maximum brightness.
- i** The behaviour specified in this parameter will be executed after each download of applications or parameters by the ETS. A simple download of the physical address alone or partial programming of only the group addresses has the effect that this parameter is disregarded and that the parameterized "Behaviour after bus voltage return" will be executed. The behaviour will moreover be executed only if bus and mains voltage supplies are connected to the device and activated.
- i** An ETS programming operation can also be performed without mains voltage. An ETS download does not require the mains voltage supply to be on.
- i** After each programming operation, the dimming actuator re-initializes itself briefly. Outputs programmed for the "universal" load type detect the load automatically. The automatic load detection procedure is characterized by the lamp flickering twice briefly in case of resistive loads and may last up to 10 seconds depending on power supply conditions.
- i** A switching state and a brightness value set after an ETS programming operation will be tracked in the feedback objects. Even after an ETS programming operation, actively transmitting feedback objects will not make their transmission unless the initialization is terminated and the "Delay after bus voltage return" has elapsed.
- i** If the parameter is set to "no reaction": After the programming operation the actuator will shut off briefly during the initialization phase. Thereafter, the brightness value that was active before will be adopted again.
- i** The manual mode, if active, will be terminated by an ETS programming operation.
- i** After an ETS programming operation, the disabling functions and the forced-control are always deactivated. The brightness values and forced-control objects stored during a bus voltage failure are deleted.

Presetting the behaviour in case of bus voltage failure

The parameter "Behaviour in case of bus voltage failure" exists separately for each output on parameter page "Ax - General" (x = number of output 1...4).

- Set the parameter to "no reaction".
In case of bus voltage failure, the output shows no reaction and remains at the currently adjusted brightness level or off.
 - Set the parameter to "0 % (shut-off)".
The output is shut off in case of bus voltage failure.
 - Set the parameter to "basic brightness" or to another brightness value (in %).
The output is adjusted to the preset brightness value. It must be ensured that the parameterized value does not exceed the preset maximum brightness.
- i** In case of mains voltage failure all outputs will be shut off. All telegrams received from the bus will be discarded. In case of mains voltage failure, switching status feedback telegrams (switching = "0", brightness = "0") are transmitted to the bus as long as the bus voltage is still present.
- i** Any active disabling or forced-control functions will be cancelled by a bus voltage failure and remain inactive until they are reactivated.
- i** During a bus or mains voltage failure, the current forced-control states are stored as well in case they must be tracked when the bus voltage returns (depending on the parameterization of the forced-control functions).
- i** In case of bus or mains voltage failure, the current brightness values of all outputs are permanently stored in the device so that these values can be readjusted after bus or mains voltage return, if so parameterized in the ETS. The data are stored before the reaction parameterized for the case of bus voltage failure occurs and only if one part of the supply voltage (mains or bus) is still present, or if the supply fails completely after the mains voltage has been available before without interruption for at least 20 seconds after the last reset (storage capacitors sufficiently charged for storage purposes). In all other cases, nothing will be stored (brightness values = "0")!

Storage takes place only once after part of the supply voltage has failed...

Example 1:

Bus voltage failure → storage → thereafter mains voltage failure → no further storage,

Example 2:

Mains voltage failure → storage → thereafter bus voltage failure → no further storage.

As the brightness values are stored only once during bus voltage failure, such values as are varied by manual control after bus voltage failure cannot be tracked.

Successfully stored brightness data are not lost during programming with the ETS.

Presetting the behaviour after bus or mains voltage return

The parameter "Behaviour after bus or mains voltage return" exists separately for each output on parameter page "Ax - General" (x = number of output 1...4).

- Set the parameter to "no reaction".
After bus/mains voltage return, the output shows no reaction and remains at the currently adjusted brightness level or off.
 - Set the parameter to "0 % (shut-off)".
The output is shut off on return of bus/mains voltage.
 - Set the parameter to "basic brightness" or to another brightness value (in %).
The output is adjusted to the preset brightness value. It must be ensured that the parameterized value does not exceed the preset maximum brightness.
 - Set the parameter to "brightness value before bus/mains voltage failure".
After bus/mains voltage return, the brightness value last adjusted before the bus/mains voltage failure and internally stored at the time of bus/mains voltage failure will be tracked.
 - Set the parameter to "activate staircase function".
The staircase function is activated after bus/mains voltage return independent of the "Switching" object. For this setting it is indispensable that the Staircase function has been programmed and enabled for the output. If the Staircase function has not been enabled, this setting will produce no reaction after return of bus/mains voltage.
- i** For all settings: On activation of the bus voltage, the brightness value is set to "0 %", if – at the time of bus voltage return – there was no mains voltage (at the load output or at the "L" and "N" terminals of the actuator).
- i** Setting "brightness value as before bus/mains voltage failure": Programming of an application or of parameters with ETS resets the stored switching state to "off – 0".
- i** Setting "no reaction": On return of bus voltage (e.g. bus reset with the mains voltage supply continuously on), the corresponding dimming output shows no reaction and remains at the brightness level last adjusted.
When the mains voltage supply is switched on (bus voltage being on or off), the dimming actuator sets the corresponding outputs to brightness level "0".
- i** After every activation of the mains voltage, the dimming actuator re-initializes itself briefly. Outputs programmed for the "universal" load type detect the load automatically. The automatic load detection procedure is characterized by the lamp flickering twice briefly in case of resistive loads and may last up to 10 seconds depending on power supply conditions.
- i** A switching state and a brightness value adjusted after bus/mains voltage return is tracked in the feedback objects. Actively transmitting feedback objects will not make their transmission after bus or mains voltage return unless the initialization of the actuator is terminated and – if programmed – the "Delay after bus voltage return" has elapsed.
- i** With Forced-control position as additional function: The communication object of the forced-control function can be initialized separately after bus voltage return. This has an effect on the reaction of the output when the Forced-control position is activated on bus voltage return. The parameterized "Behaviour after bus or mains voltage return" will only be executed, if no Forced-control position is activated after bus voltage return.
- i** With disabling function as additional function: Active disabling functions are always inactive after bus or mains voltage return.
- i** An active manual control is terminated on return of bus voltage. In case of mains failure, no manual control is possible.

Feedback for switching status and brightness value

The dimming actuator can track the current switching state and brightness value of a dimming output via separate feedback objects and also transmit them to the bus, if the bus voltage is on. The following feedback objects can be enabled separately for each dimming output...

- switching status feedback (1 bit),
- brightness value feedback (1 byte)

The actuator computes the value of the feedback objects for switching or dimming operation. Even if an output is activated by manual control or by the scene function, the actuator tracks the switching state or the brightness value and updates the feedback objects.

The switching status feedback object is updated after the following events...

- immediately after activation of an output (only after an ON-delay - if applicable - has elapsed and at the beginning of a soft-ON dimming procedure / also with a Staircase function),
- after deactivation of an output (only after an OFF-delay - if applicable - has elapsed and at the beginning of a soft-OFF dimming procedure / also with a Staircase function),
- immediately after shut-off by the automatic shut-off function,
- at the beginning of a dimming cycle when an output is activated (relative increase of brightness or brightness value = 1...100 %),
- at the end of a dimming cycle when an output is deactivated (brightness value = 0 %)
- only when the switching state changes (i.e. not for dimming cycles without change of the switching state, e.g. from 10 % brightness to 50 % brightness),
- during updates of the switching state from "ON" to "ON", if the output was already on,
- during updates of the switching state from "OFF" to "OFF", if the output was already off,
- always at the beginning or at the end of a disabling or forced-control function (only if the switching state is changed thereby),
- always on return of bus/mains voltage, in case of mains voltage failure ("OFF") or at the end of an ETS programming operation (if applicable, also with a time delay and after automatic load detection).

The brightness feedback object is updated after the following events...

- at the end of a relative (4-bit) or absolute (1-byte) dimming procedure,
- after activation of an output when the switch-on brightness has been adjusted (only after an ON-delay - if applicable - has elapsed and at the end of a soft-ON dimming procedure / also with a Staircase function),
- after deactivation of an output (only after an OFF-delay - if applicable - has elapsed and at the beginning of a soft-OFF dimming procedure / also with a Staircase function),
- immediately after shut-off by the automatic shut-off function,
- only when the brightness value changes (if a brightness value preset by relative or absolute dimming from an external source exceeds the maximum brightness, the actuator will NOT update a brightness value feedback with regard to maximum brightness)
- always at the beginning or at the end of a disabling or forced-control function (only if the brightness value is changed thereby),
- always on return of bus/mains voltage, in case of mains voltage failure ("0") or at the end of an ETS programming operation (if applicable, also with a time delay and after automatic load detection).

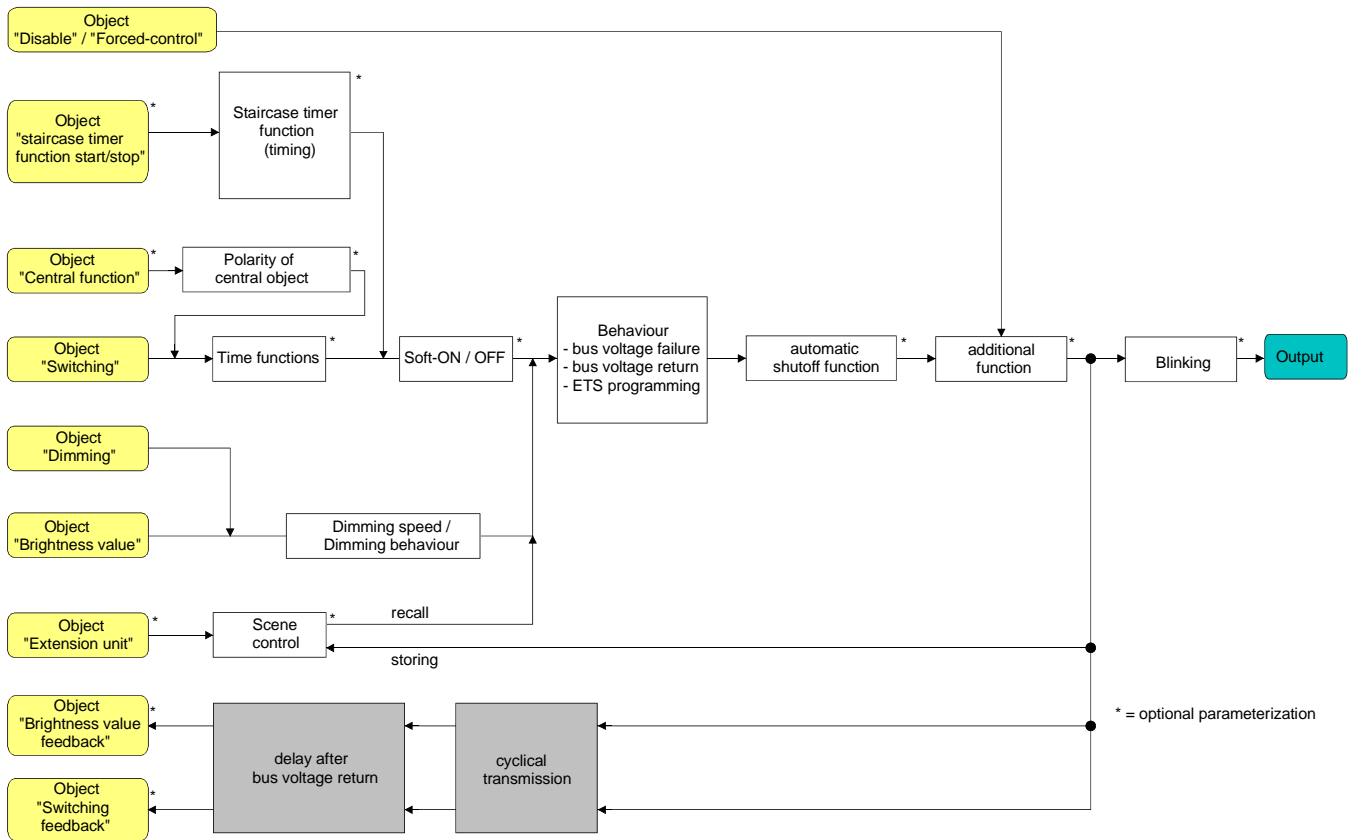

Fig. 6: Functional feedback diagram

i With disabling function as additional function: A 'blinking' output will always be reported back as "switched on" and with switch-on brightness. Switching status feedback telegrams will also be transmitted for disabled outputs, for instance, if these outputs are readjusted by manual control.

Activating the switching status feedback function

The switching status feedback can be used as an active message object or as a passive status object. As an active message object, the switching status feedback information is transmitted directly to the bus after each update. As a passive status object, there is no telegram transmission in case of an update. In this case, the object value must be read out. The ETS automatically sets the object communication flags required for proper functioning.

The parameter "Switching status feedback ?" exists separately for each output on parameter page "Ax – Feedbacks" (x = number of output 1...4).

The feedbacks must be enabled on parameter page "Ax - Enabled functions".

- Set the parameter to "feedback object is active message object".
The "Switching status feedback" object is enabled. The switching status is transmitted as soon as the status is updated. After bus/mains voltage return or after an ETS programming operation, the feedback message is transmitted automatically.
- Set the parameter to "feedback object is passive status object".
The "Switching feedback" object is enabled. The switching status will be transmitted in response only when the feedback object is read out from by the bus. After bus/mains voltage return or after an ETS programming operation there will no automatic transmission of the feedback telegram.
- Set the parameter to "no feedback".
The switching status feedback is deactivated.

i Feedback of the current switching status via the "Switching" object is not possible.

Presetting the switching status feedback in case of bus/mains voltage return or after an ETS programming operation

If used as active message object, the state of the switching status feedback is transmitted to the bus after bus or mains voltage return or after an ETS programming operation. In these cases, the feedback telegram can be time-delayed with the delay being preset globally for all outputs together (cf. "Delay after bus/mains voltage return").

- Set the parameter "Time delay for feedback telegram after bus voltage return ?" on parameter page "Ax - Feedbacks" (x = number of output 1...4) to "yes".
The switching status feedback telegram will be transmitted with a delay after bus or mains voltage return or after an ETS programming operation. No feedback telegram is transmitted during a running delay, even if the switching state changes during the delay.
- Set the parameter "Time delay for feedback telegram after bus voltage return ?" on parameter page "Ax - Feedbacks" (x = number of output 1...4) to "no".
The switching status feedback telegram will be transmitted immediately after bus or mains voltage return or after an ETS programming operation.

i On return of mains voltage or after an ETS programming operation, the switching status feedback telegram is always transmitted with a basic delay of a few seconds (initialization of the dimming actuator or automatic load type detection). The basic delay is added to the "Delay after bus/mains voltage return" parameterized in the ETS, if such delay is activated.

Presetting cyclical transmission for switching status feedback telegrams

In addition to being transmitted in case of an update, the switching status feedback telegram can also be transmitted cyclically via the active message object.

- Set the parameter "Cyclical transmission of feedback telegram ?" on parameter page "Ax - Feedbacks" (x = number of output 1...4) to "yes".
Cyclical transmission is now activated.
 - Set the parameter "Cyclical transmission of feedback telegram ?" on parameter page "Ax - Feedbacks" (x = number of output 1...4) to "no".
Cyclical transmission is deactivated which means that a feedback telegram is transmitted to the bus only when a switching status is updated.
- i** The cycle time is defined centrally for all outputs on parameter page "Time settings"
- i** During an active delay after bus/mains voltage return no feedback telegram will be transmitted even if a switching state changes.

Activating the brightness feedback

The brightness value feedback can be used as an active message object or as a passive status object. As an active message object, the brightness value feedback is transmitted directly to the bus after each update. As a passive status object, there is no telegram transmission in case of an update. In this case, the object value must be read out. The ETS automatically sets the object communication flags required for proper functioning.

The parameter "Brightness value feedback ?" exists separately for each output on parameter page "Ax - Feedbacks" (x = number of output 1...4).

The feedbacks must be enabled on parameter page "Ax - Enabled functions".

- Set the parameter to "feedback object is active message object".
The "Brightness value feedback" object is enabled. The brightness value is transmitted as soon as it is updated. After bus/mains voltage return or after an ETS programming operation, the feedback message is transmitted automatically.
 - Set the parameter to "feedback object is passive status object".
The "Brightness value feedback" object is enabled. The brightness value will be transmitted in response only when the feedback object is read out from by the bus. After bus/mains voltage return or after an ETS programming operation there will no automatic transmission of the feedback telegram.
 - Set the parameter to "no feedback".
The brightness value feedback is deactivated.
- i** Feedback of the current brightness value via the "Brightness value" object is not possible even if the T flag is set.

Presetting the brightness value feedback in case of bus/mains voltage return or after an ETS programming operation

If used as active message object, the brightness value feedback status is transmitted to the bus after bus or mains voltage return or after an ETS programming operation. In these cases, the feedback telegram can be time-delayed with the delay being preset globally for all outputs together (cf. "Delay after bus/mains voltage return").

- Set the parameter "Time delay for feedback telegram after bus voltage return?" on parameter page "Ax - Feedbacks" (x = number of output 1...4) to "yes".
The brightness value feedback telegram will be transmitted with a delay after bus or mains voltage return or after an ETS programming operation. No feedback telegram is transmitted during a running delay, even if the brightness value changes during the delay.
- Set the parameter "Time delay for feedback telegram after bus voltage return?" on parameter page "Ax - Feedbacks" (x = number of output 1...4) to "no".
The brightness value feedback telegram will be transmitted immediately after bus or mains voltage return or after an ETS programming operation.

i On return of mains voltage or after an ETS programming operation, the switching status feedback telegram is always transmitted with a basic delay of a few seconds (initialization of the dimming actuator or automatic load type detection). The basic delay is added to the "Delay after bus/mains voltage return" parameterized in the ETS, if such delay is activated.

Presetting cyclical transmission for brightness value feedback telegrams

In addition to being transmitted in case of an update, the brightness value feedback telegram can also be transmitted cyclically via the active message object.

- Set the parameter "Cyclical transmission of feedback telegram ?" on parameter page "Ax - Feedbacks" (x = number of output 1...4) to "yes".
Cyclical transmission is now activated.
- Set the parameter "Cyclical transmission of feedback telegram ?" on parameter page "Ax - Feedbacks" (x = number of output 1...4) to "no".
Cyclical transmission is deactivated which means that the feedback telegram is transmitted to the bus only when a brightness value is updated.

i The cycle time is defined centrally for all outputs on parameter page "Time settings"

i During an active delay after bus/mains voltage return no feedback telegram will be transmitted even if a brightness value changes.

Time delays

Up to two time functions can be preset independently for each output. The time functions act solely on the communication objects "Switching" or "Central function" (if a central has been activated for the output in question) and delay the received object value as a function of telegram polarity (cf. fig. 7).

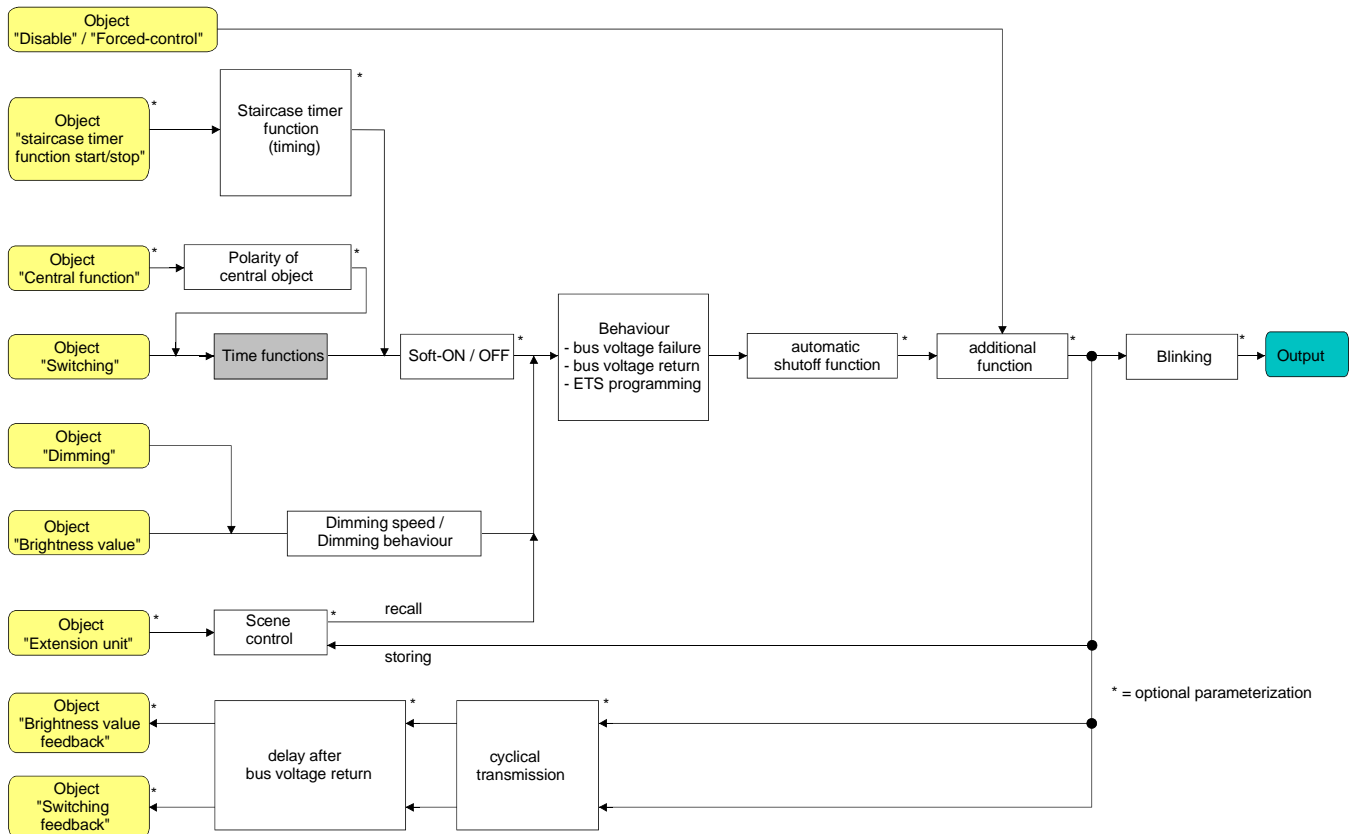

Fig. 7: Functional diagram of the time delays

Activating an ON-delay

The load failure detection can be enabled separately for each output in the ETS.

The time delays must be enabled on parameter page "Ax - Enabled functions".

- Set the parameter "Selection of time delay" on parameter page "Ax – Time delays" to "ON-delay" or to "ON-delay and OFF delay". Parameterize the desired ON-delay.

The ON-delay is now enabled. After reception of an ON-telegram via the "Switching" object, the parameterized time is started. A subsequent ON-telegram retriggers the time only if the parameter "ON-delay retriggerable ?" has been set to "yes". An OFF-telegram received during the ON-delay ends the delay and sets the switching status to "OFF".

Activating an OFF-delay

The OFF-delay can be enabled in the ETS separately for each output.

The time delays must be enabled on parameter page "Ax - Enabled functions".

- Set the parameter "Selection of time delay" on parameter page "Ax – Time delays" (x = number of output 1...4) to "OFF-delay" or to "ON-delay and OFF delay". Parameterize the desired OFF-delay. The OFF-delay is now enabled. After reception of an OFF telegram via the "Switching" object, the parameterized time is started. A subsequent OFF-telegram retriggers the time only if the parameter "OFF-delay retriggerable ?" has been set to "yes". An ON-telegram received during the OFF-delay ends the delay and sets the switching status to "ON".
- ❗ Feedback: If a time delay has been preset and if the switching state is changed via the "Switching" object, the time delay must have elapsed before feedback telegrams will be transmitted. Updates of the object from "ON" to "ON" or from "OFF" to "OFF" by retriggering during a running time delay has no influence on the switching status feedback.
- ❗ At the end of a disabling or forced-control function, the brightness value received during or set before the function can be tracked. Residual times of time functions are tracked, if they have not completely elapsed at the time the disabling or forced-control functions are disabled.
- ❗ The time delays have no influence on the Staircase functions, if these are enabled.
- ❗ A time delay in progress will be completely terminated by a reset of the actuator (bus/mains voltage failure or ETS programming operation).

Soft-ON/OFF function

The 'soft functions' allow to slow down the activation and deactivation of a dimming output, when a switching command is being received via the communication objects "Switching" or "Central function". When the soft-ON function is activated, the brightness is increased up to the parameterized switch-on brightness. This is also the case when the output is already active with a brightness value corresponding to a lower switch-on brightness. When the soft-OFF function is activated, the brightness is likewise reduced down to 0 % when an OFF-telegram is being received.

The brightness variation speeds can be parameterized in the ETS separately for the soft-ON as well as for the soft-OFF function. The value parameterized is the relative dimming step time between 2 of 255 dimming steps.

The soft-ON or the soft-OFF functions cannot be retriggered by the reception of further switching telegrams with the same switching status. The 'soft functions' can be configured and activated in the ETS separately of one another.

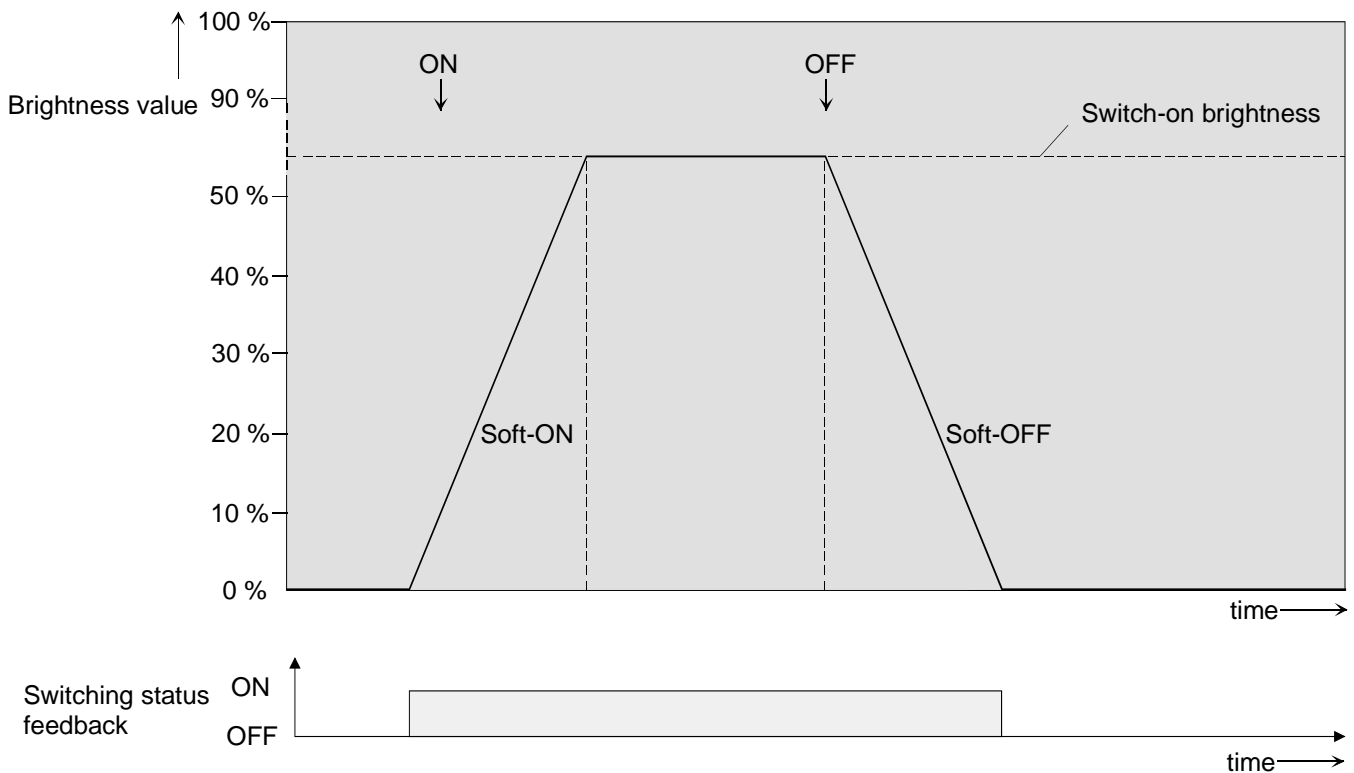

Fig. 8: Dimming behaviour of the soft-ON/OFF functions (example)

Figure 9 shows the functional diagram of the 'soft functions'. The 'soft functions' also have an effect on the switching pulse edges of the Staircase function.

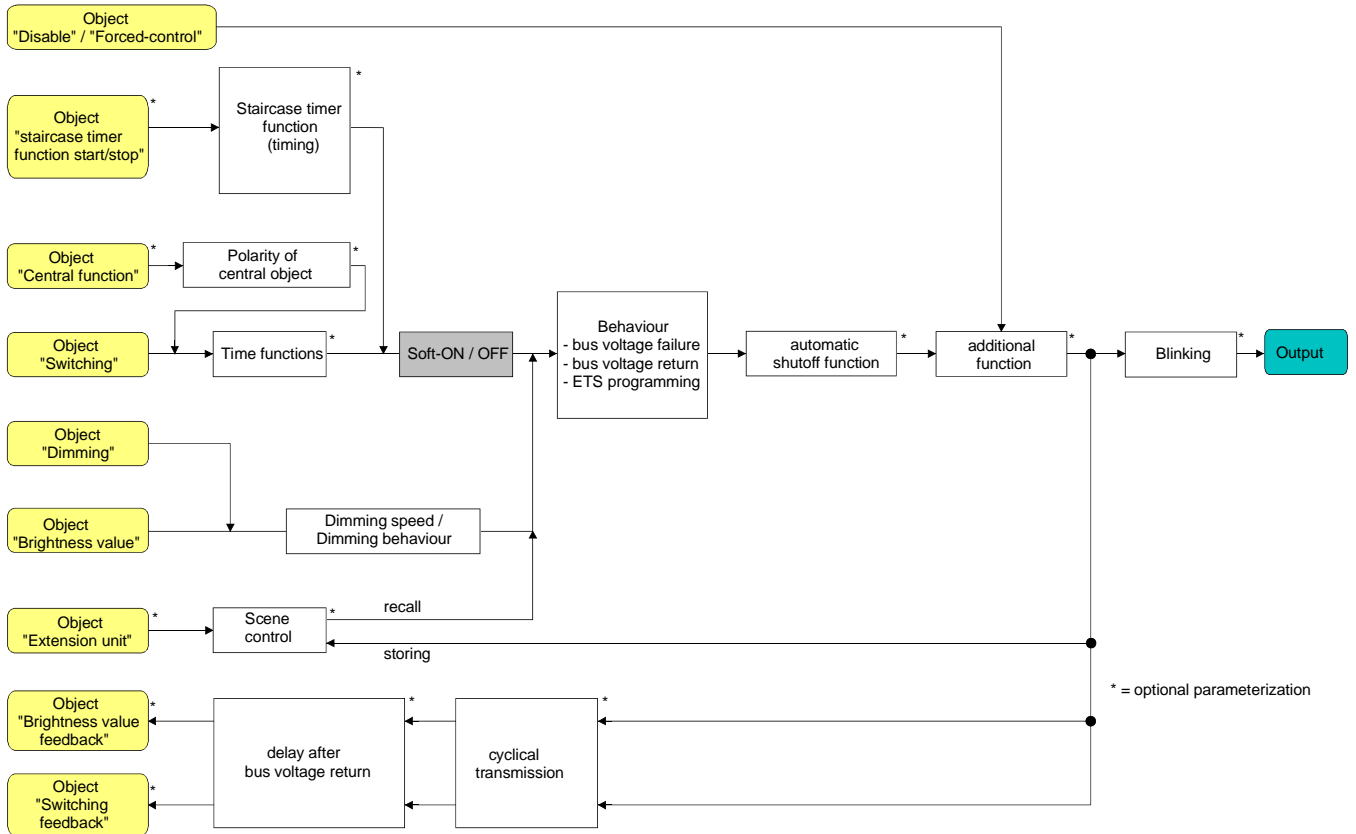

Fig. 9: functional diagram of the 'soft functions'

i Depending on the parameterization of the disabling function, an output disabled via the bus can also be made to blink. The ON and OFF blinking sequence does not make use of the SOFT functions.

Enabling and presetting the soft-ON function

The soft-ON function can be enabled separately for each output in the ETS.

The switch-on/switch-off behaviour must be enabled on parameter page "Ax – Enabled functions (x = number of output 1...4).

- Set the parameter "Soft-ON function ?" on parameter page "Ax – Switch-on/switch-off behaviour" to "yes".

The soft-ON function is then enabled. The parameter for the dimming step time (time between 2 of 255 dimming steps) of the soft-ON function is then visible.

- Set the parameter "Time for dimming step soft-ON" to the required dimming step time.

Enabling and presetting the soft-OFF function

The soft-OFF function can be enabled separately for each output in the ETS.

The switch-on/switch-off behaviour must be enabled on parameter page "Ax – Enabled functions (x = number of output 1...4).

- Set the parameter "Soft-OFF function ?" on parameter page "Ax – Switch-on/switch-off behaviour" to "yes".

The soft-OFF function is then enabled. The parameter for the dimming step time (time between 2 of 255 dimming steps) of the soft-OFF function is then visible.

- Set the parameter "Time for dimming step soft-OFF" to the required dimming step time.

Automatic shut-off

The shut-off function permits shutting off a dimming output automatically if a dimming value has been set by direct or gradual approach and if this new brightness value is below a shut-off brightness level fixed in the ETS. As an option, a delay before shut-off can be programmed (cf. fig. 10).

The shut-off function is activated only after a constant brightness level has been reached, i.e. after an accomplished dimming procedure. A new dimming procedure ending equally below the shut-off brightness restarts a time delay, if parameterized. Similarly, the shut-off function will be interrupted when the shut-off brightness level is exceeded in a dimming procedure.

The use of the automatic shut-off function permits, for instance, setting the lighting by relative dimming not only to the basic brightness, but also shutting it off. Another application consists in the time-controlled 'good-night shut-off' of a dimmed lamp in a child's bedroom.

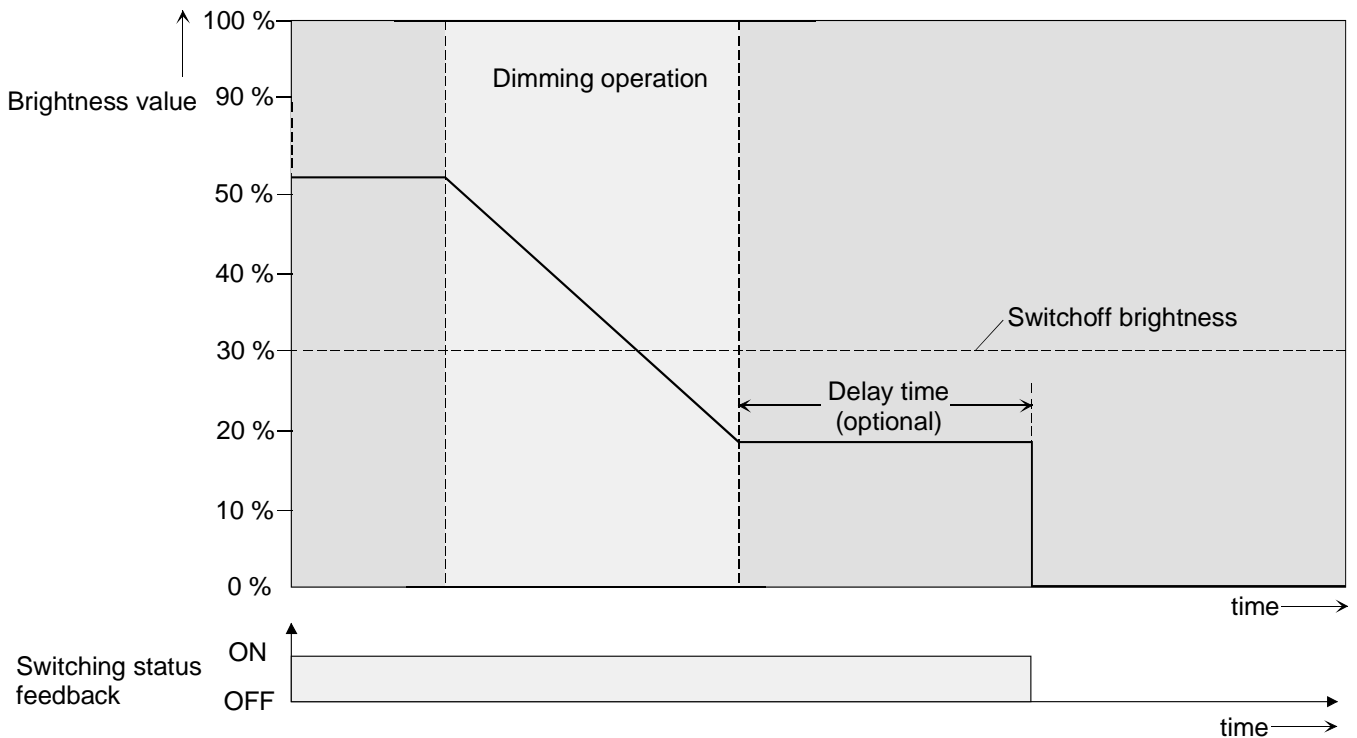

Fig. 10: Dimming and switching behaviour of the automatic shut-off function

- i** Shutting off is basically performed instantaneously, i.e. without soft-OFF function.
- i** The shut-off brightness can be selected within the dimmable brightness range between basic and maximum brightness. The shut-off function is permanently active if the shut-off brightness is programmed for maximum brightness and if the actual brightness is at any level below the maximum brightness.
- i** The feedback objects for switching state and brightness value are updated by the automatic shut-off function after the shut-off.

The automatic shut-off function can be activated on the one hand by means of a dimming cycle initiated via the 4-bit ("Dimming") or the 1-byte ("Brightness value") communication objects. On the other hand, the automatic shut-off is activated also in that case where an output is switched on (switch-on brightness < shut-off brightness) or where a brightness level is set by an ETS programming operation or by bus voltage failure or by bus/mains voltage return. The automatic shut-off function can also be activated in case of a scene recall.

It should be noted that the disabling function or the forced-control function overrides the shut-off function (cf. fig. 11). When the shut-off function is overridden, the actuator stops the evaluation of the shut-off brightness.

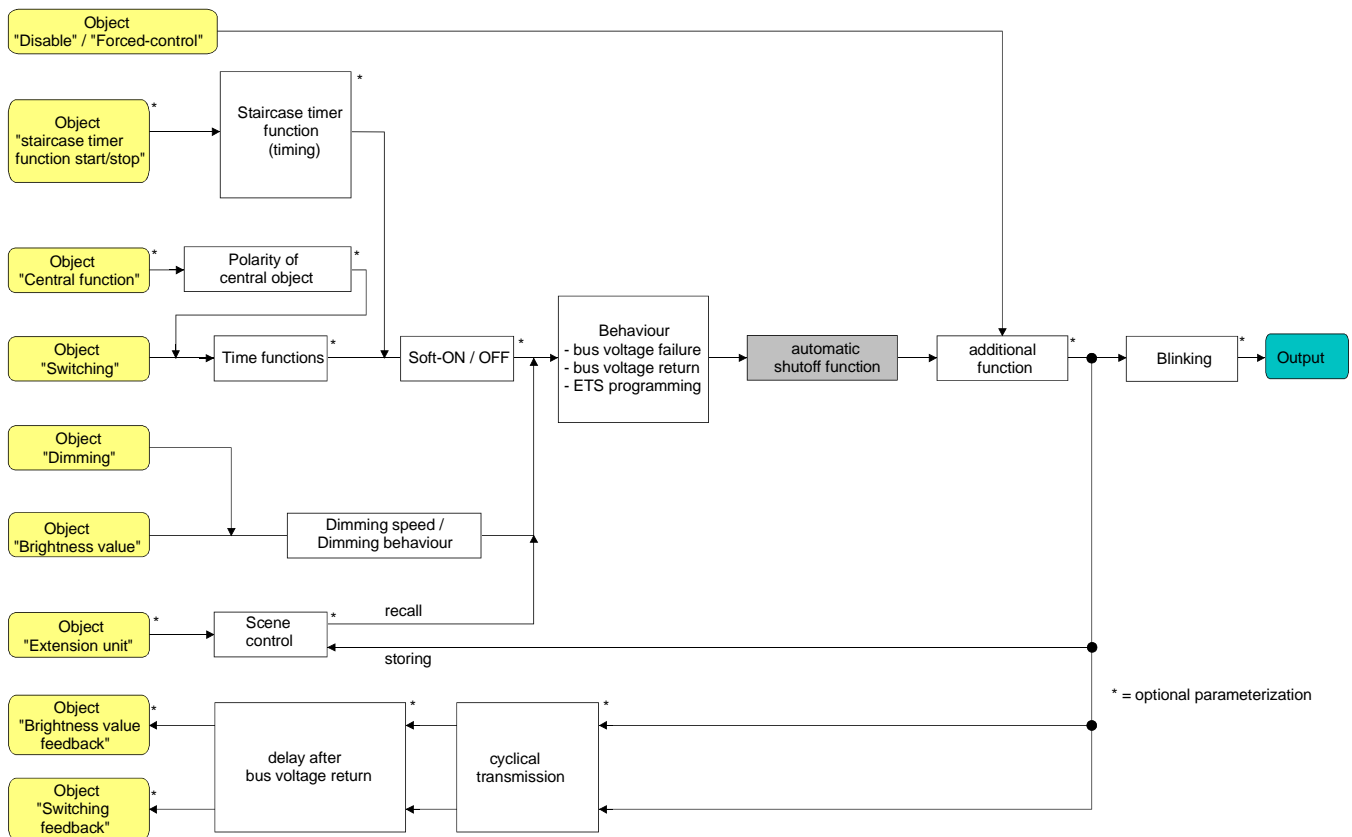

Fig. 11: Functional diagram of the automatic shut-off function

Enabling the automatic shut-off function

The automatic shut-off function can be enabled separately for each output in the ETS.

The switch-on/switch-off behaviour must be enabled on parameter page "Ax – Enabled functions (x = number of output 1...4).

- Set the parameter "Automatic shutoff when falling below a specified brightness ?" on parameter page "Ax – Switch-on/switch-off behaviour" to "yes".

The automatic shut-off function is enabled and activated. Further parameters are displayed.

Presetting the shut-off brightness

If the shut-off function is to be used it is necessary to define the shut-off brightness. The shut-off brightness is preset in the ETS separately for each output.

The shut-off function must have been enabled.

- Set the parameter "Shutoff when brightness value smaller" on parameter page "Ax – Switch-on/switch-off behaviour" to the desired brightness level.

If the brightness falls during dimming below the parameterized shut-off brightness level and is then constant, the output concerned shuts off or alternatively starts the delay before shut-off.

- ❗ It must be ensured that the parameterized shut-off brightness value does not exceed the preset maximum brightness level.
- ❗ When the Staircase function with pre-warning is used: The reduced brightness of the pre-warning launches the shut-off function when reaching or when falling below the shut-off brightness level.

Presetting the shut-off function delay

Before the shut-off function shuts off automatically when the brightness falls below the shut-off brightness at the end of a dimming cycle, a time delay can be activated. If desired, the time delay can be enabled separately for each output.

The shut-off function must have been enabled.

- Set the parameter "Delay until shutoff" on parameter page "Ax – Switch-on/switch-off behaviour" to the desired duration of the delay.

If a dimming cycle causes the brightness to fall below the parameterized shut-off brightness level and then to remain at a constant level, the actuator triggers the delay. The output concerned shuts off definitely when the delay has ended. The delay can be retriggered by subsequent dimming cycles.

Staircase timer function

The separately programmable staircase timer function can be used for implementing a time-controlled staircase lighting function or functionally similar applications. The Staircase function must have been enabled on parameter page "Ax – Enabled functions" (x = number of output 1...4) before the required communication objects and parameters become available.

The staircase function is controlled by means of the "Staircase function start / stop" communication object and is independent of the "Switching" object of an output (cf. fig. 12). This feature permits 'parallel operation' of time and normal control, with always the last command being executed. A telegram to the "Switching" object when the staircase function is active ends the staircase time prematurely and sets the output to the switching state corresponding to the object value received (time delays are taken into account). Similarly, the switching state of the "Switching" object can be overridden by a staircase function.

In combination with a disabling function, a time-independent permanent lighting function can also be realized. The staircase function can be enlarged by a additional function. One possibility consists in the activation of a time extension. The "time extension" permits retriggering an activated staircase time n times via the object "Staircase function start / stop". As an alternative, "time definition via bus" can be selected. With this additional function, the parameterized staircase time can be multiplied with a factor received from the bus and thus dynamically adapted. The staircase function can moreover be enlarged by a separate ON-delay and by a pre-warning function. During the pre-warning, the brightness of a dimming output can be reduced. In acc. with DIN 18015-2, the pre-warning function is designed to warn persons in the staircase that the lights will go out shortly.

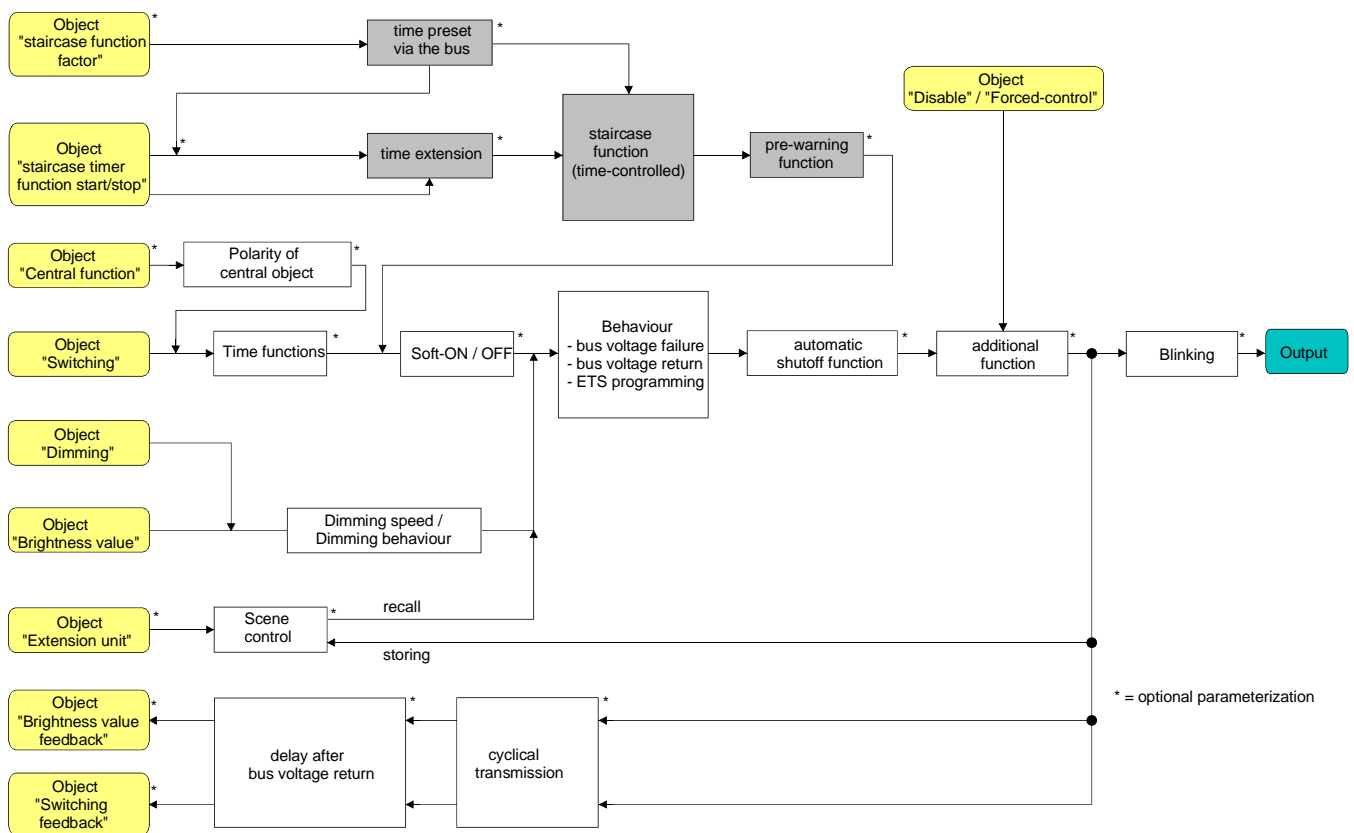

Fig. 12: Functional diagram of the Staircase function

Defining the switch-on behaviour of the staircase function

An ON-telegram to the "Staircase function start / stop" activates the staircase lighting time (T_{ON}) the duration of which is defined by the parameter "Staircase lighting time". The output is activated with the switch-on brightness. At the end of the staircase lighting time, the output switches off or optionally activates the pre-warning time ($T_{pre-warn}$) of the pre-warning function (cf. Presetting the pre-warning function of the Staircase function). With the pre-warning function, the Staircase function has the switch-on behaviour as shown in fig. 13.

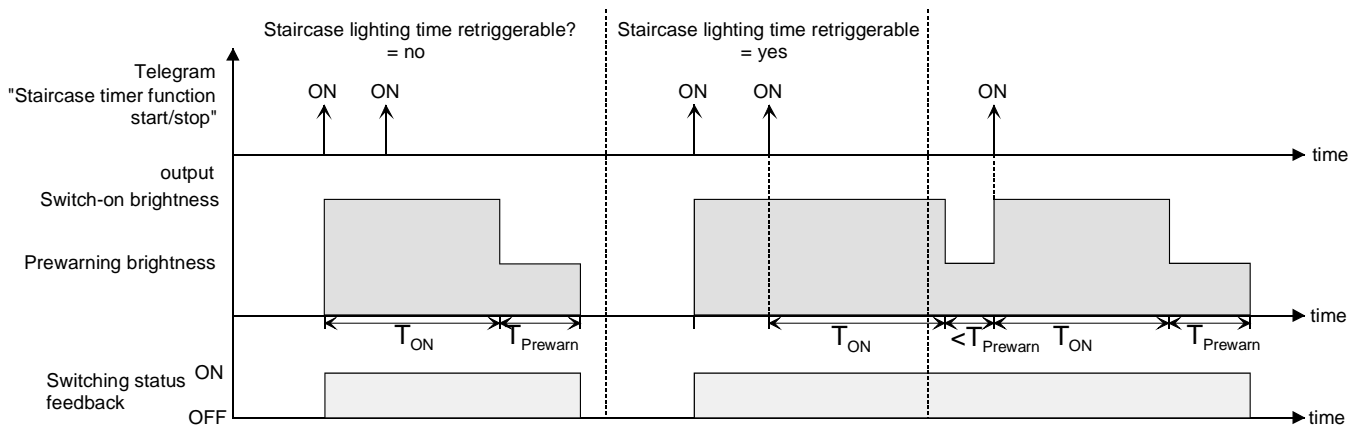

Fig. 13: Switch-on behaviour of the staircase function without 'soft functions'

Additionally, the switch-on behaviour of the actuator can be influenced by the 'soft functions'. With a soft-ON and a soft-OFF function, the Staircase function has the switch-on behaviour as shown in fig. 14.

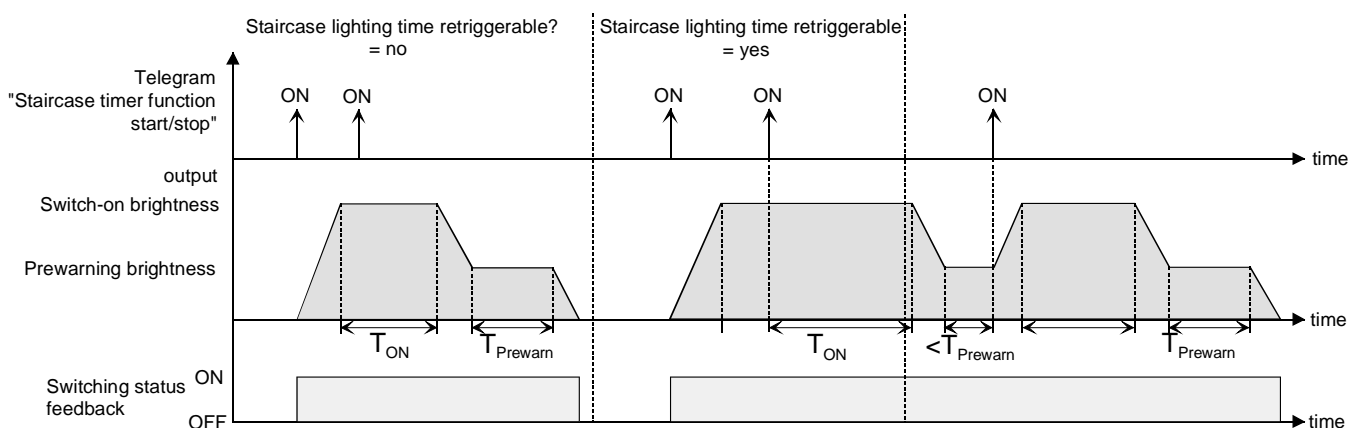

Fig. 14: Switch-on behaviour of the staircase function with 'soft functions'
(example: with minimum brightness = 0 %)

- Set the parameter "Staircase function ?" on parameter page "Ax - Enabled functions" (x = number of output 1...4) to "enabled".
The Staircase function is enabled. The other parameters on parameter page "Ax – Staircase function" are now visible
 - Define the required ON-time of the staircase timer in the "Staircase time" parameter on parameter page "Ax – Staircase function".
 - Set the parameter "Staircase time retriggerable ?" on parameter page "Ax – Staircase function" to "yes".
Every ON-telegram received during the ON-phase of the staircase lighting time retriggers the staircase time completely.
 - The parameter "Staircase time retriggerable ?" is alternatively set to "no".
ON-telegrams received during the ON-phase of the staircase time will be rejected. The staircase lighting time will not be retriggered.
- i** An ON-telegram received during the pre-warning time always retriggers the staircase time independent of the "Staircase time retriggerable ?" parameter.

Defining the switch-off behaviour of the staircase function

In a staircase function, the reaction to an OFF-telegram to the "Staircase function start / stop" object can also be parameterized. Without reception of an OFF-telegram, an output may shut off after the pre-warning time has elapsed. With the pre-warning function, the staircase function has the shut-off behaviour shown in fig. 15.

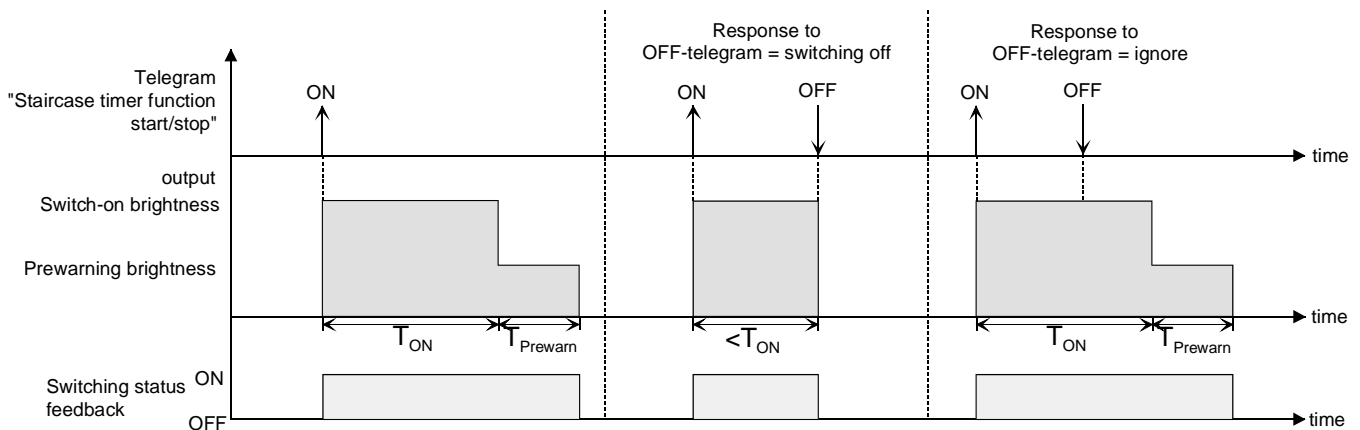

Fig. 15: Shut-off behaviour of the staircase function without 'soft functions'

Additionally, the shut-off behaviour of the actuator can be influenced by the 'soft functions'. With a soft-ON and a soft-OFF function, the staircase function has the shut-off behaviour shown in fig. 16.

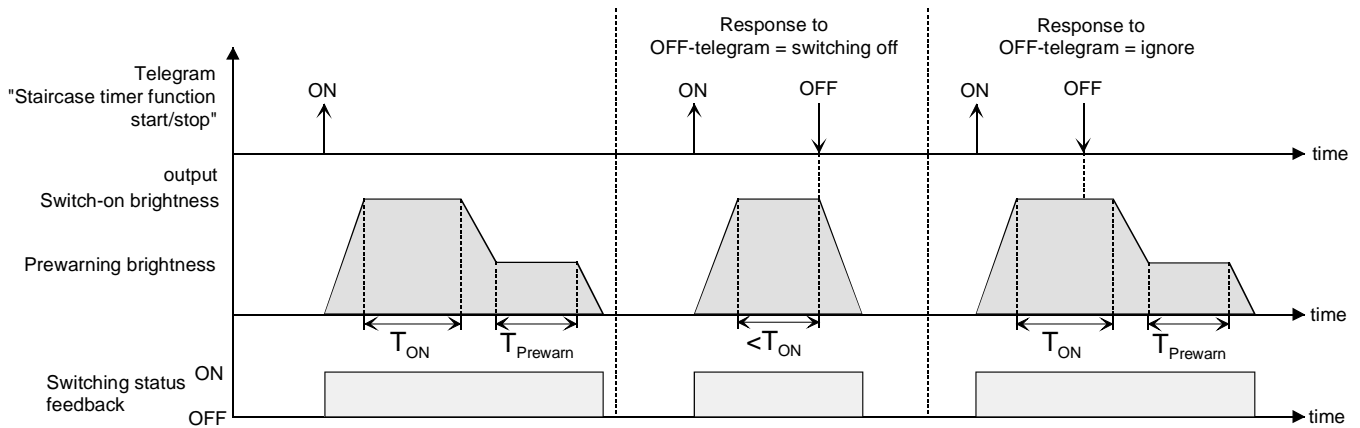

Fig. 16: Shut-off behaviour of the staircase function with 'soft functions'
(example: with minimum brightness = 0 %)

The parameter "Response to OFF-telegram" on parameter page "Ax – Staircase function" (x = number of output 1...4) defines whether the staircase time (T_{ON}) of the Staircase function can be stopped prematurely.

The staircase function must be enabled.

- Set the parameter "Response to OFF-telegram" to "switch-off".
The output concerned shuts off immediately when an OFF-telegram is received via the object "Staircase function start / stop" during the ON-phase of the staircase time. If the staircase time is stopped prematurely by such a telegram, there is no pre-warning, i.e. the pre-warning time is not started.
Premature shut-off is also possible during a dimming cycle, a 'soft function' or a pre-warning.
- Set the parameter "Response to OFF-telegram" to "ignore".
OFF-telegrams received during the ON-phase of the staircase time via the "Staircase function start / stop" object will be rejected. The staircase time will be executed completely, if applicable with a pre-warning.

Presetting the pre-warning function of the staircase function

As per DIN 18015-2, the pre-warning function is designed to warn persons still in the staircase that the lights will go out shortly. For pre-warning purposes, a dimming output can be preset to a pre-warning brightness before the output shuts off definitely. As a rule, the pre-warning brightness level is lower than that of the switch-on brightness. The pre-warning time ($T_{pre-warn}$) and the pre-warning brightness can be parameterized separately (cf. fig. 17).

The pre-warning time is added to the staircase time (T_{ON} .) The pre-warning time has an influence on the feedback object values so that switching status "OFF" and value "0" are tracked in the feedback objects only after the pre-warning time has elapsed.

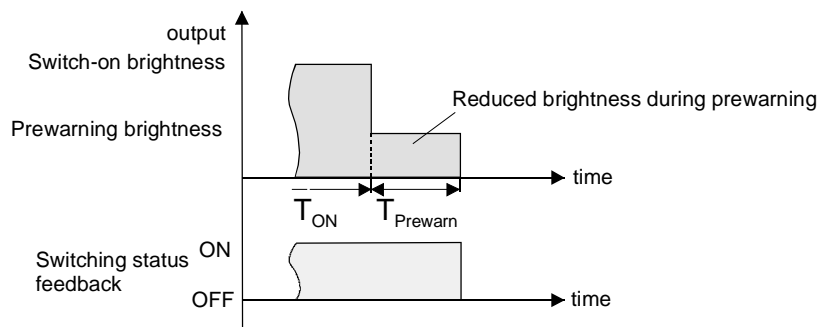

Fig. 17: The pre-warning function of the Staircase function without soft-OFF function

Additionally, the pre-warning function can also be enlarged by the soft-OFF function. With a soft-OFF function, the staircase function has the shut-off behaviour after pre-warning shown in fig. 18.

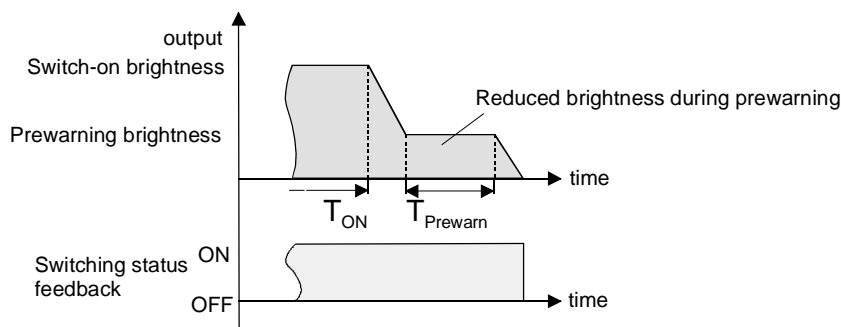

Fig. 18: The pre-warning function of the Staircase function with soft-OFF function
(example: with minimum brightness = 0 %)

i The pre-warning brightness must not necessarily be lower than the switch-on brightness. Basically, the pre-warning brightness can be parameterized with a value between basic and maximum brightness.

The staircase function must be enabled.

- Set the parameter "Activate pre-warning time ?" on parameter page "Ax – Staircase function" (x = number of output 1...4) to "yes".
The pre-warning function is now enabled. The desired pre-warning time ($T_{\text{pre-warn}}$) can then be preset.
 - Set the parameter "Reduced brightness during pre-warning time (1...100 %)" on parameter page "Ax – Staircase function" to the desired brightness.
Within the pre-warning time, the output is set to the parameterized brightness value.
- i** The parameterized value of the reduced brightness must be less than or equal to the maximum brightness value!
- i** With an ON-telegram to the "Staircase function start / stop" object during an active pre-warning function, the pre-warning time is stopped and the staircase time always restarted (independent of the "Staircase time retriggerable ?" parameter). The parameter "Response to OFF-telegram" is also evaluated during the pre-warning time so that an active pre-warning can be stopped prematurely by shutting off.
- i** When the automatic shut-off function is being used: The reduced brightness of the pre-warning launches the shut-off function when reaching or when falling below the shut-off brightness level.

Presetting the "Time extension" as additional function to the staircase function

With the time extension function, the staircase time can be retriggered several times (i.e. extended) via the "Staircase function start / stop" object. The duration of the extension is defined by repeated operation of a control device (several ON-telegrams in succession). The parameterized staircase time can thus be extended by the parameterized factor (max. 5-fold). The extension is then always automatically added to the end of a simple staircase time (T_{ON}) (cf. fig. 19).

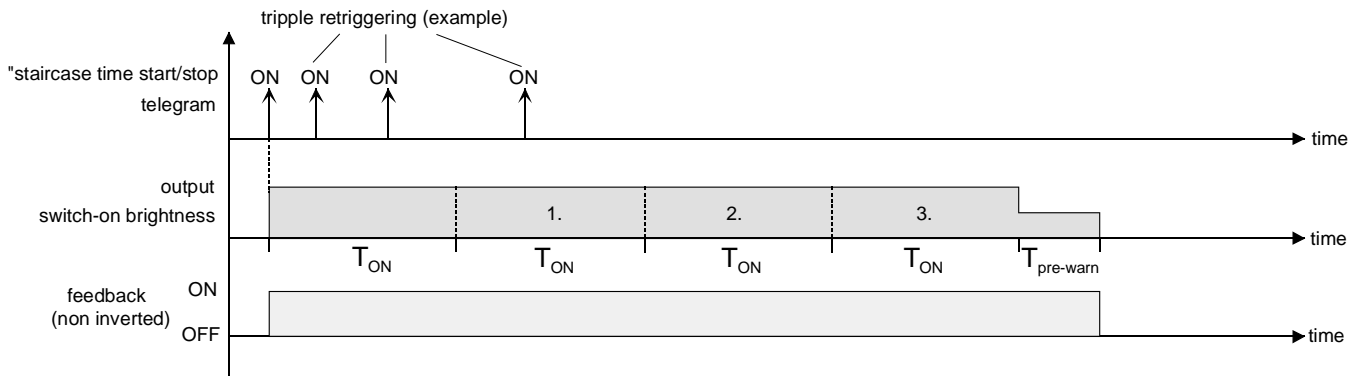

Fig. 19: Time extension for staircase function

With this function, the lighting time in a staircase can be extended (e.g. by a person after shopping) by a defined length without having to retrigger the lighting every time the lighting shuts off.

The staircase function must have been enabled on parameter page "Ax – Enabled functions".

- Set the parameter "Supplementary function for staircase function" on parameter page "Ax – Staircase function" to "Time extension" and select the desired factor in the "Maximum time extension" parameter.

On reception of an ON-telegram to the "Staircase function start / stop" object, the staircase time is retriggered at the end of the ON-time as often as determined by the number of telegrams received, however, only as often as permitted by the parameterized factor.

Thus, the setting "3-fold" means that the started staircase time can be automatically retriggered at maximum three more times after elapsing. This means that the time corresponds to 4 times the basic time (cf. fig. 19).

- ❗ Triggering of an extension can occur during the whole staircase time (T_{ON}). There is no restriction as to the time between two telegrams triggering an extension.
Time extension telegrams are evaluated only during the staircase time. An ON-telegram during the pre-warning time triggers the staircase time like in a new start making another time extension possible.
- ❗ If a time extension has been parameterized as a additional function, the parameter "Staircase time retriggerable ?" is fixed to "no" since retriggering is effected by the time extension.

Presetting the "Time preset via the bus" as additional function to the Staircase function

With the time preset via the bus function, the parameterized staircase time can be multiplied with an 8-bit factor received from the bus and thus dynamically adapted. In this setting, the factor is derived from the "Staircase time factor" object. The factor for setting the staircase time lies in a range between 1...255.

The overall staircase time is the product of the factor (object value) and the base (parameterized staircase time) as follows...

Staircase time = (staircase time object value) x (staircase time parameter)

Example:

object value "Staircase time factor" = 5; parameter "Staircase time" = 10s.

→ staircase time selected = 5 x 10s = 50 s.

As an alternative, it is possible to define in the parameters of the staircase function whether the reception of a new factor starts at the same also the staircase time of the staircase function. In this case, the "Staircase function start / stop" object is not existing and starting and stopping is controlled by the factor value received.

The staircase function must have been enabled on parameter page "Ax – Enabled functions".

- Set the parameter "Supplementary function for staircase function" on parameter page "Ax – Staircase function" to "Time preset via the bus" and the parameter "Staircase function activatable via object 'Staircase function factor' ?" to "no".

The staircase time can be adapted dynamically by means of the "Staircase function factor" object. A value of "0" is interpreted as a value of "1". Starting and stopping of the Staircase function is effected exclusively via the "Staircase function start / stop" object.

- Set the parameter "Supplementary function for staircase function" on parameter page "Ax – Staircase function" to "Time preset via the bus" and the parameter "Staircase function activatable via object 'Staircase function factor' ?" to "yes".

The staircase time can be adapted dynamically by means of the "Staircase function factor" object. In addition, the staircase function is started on reception of a new factor with the new staircase time (the "Staircase function start / stop" object is not existing). A factor value of "0" is interpreted as an OFF-telegram with the parameterized reaction to an OFF-telegram being evaluated in this case, too.

A large staircase with several floors is a good example for a possible application of the 'time preset via the bus' function with automatic starting of the staircase time. A push button sensor on each floor of the house transmits a factor value to the staircase function. The higher the floor, the greater the transmitted factor value in order to ensure that the lights remain on longer when it takes more time to reach the upper floors. When a person enters the staircase of the house and after pressing of the touch sensor key, the staircase time is now dynamically adapted and the lighting switched on at the same time.

- i** Setting "Staircase function activatable via object 'Staircase function factor' ?" = "yes": A factor of > 0 received during the pre-warning time always retrigger the staircase lighting time independent of the "Staircase time retriggerable ?" parameter.
- i** After a reset (bus or mains voltage return or ETS programming operation), the "Staircase function factor" object is always initialized with a "1". This alone is not sufficient for automatic starting of the staircase function (cf. "Presetting the behaviour of the staircase function after bus voltage return").
- i** The two supplementary functions "Time extension" and "Time preset via the bus" can now be parameterized as an alternative.

Presetting the behaviour of the staircase function after bus/mains voltage return

As an option, the staircase function can be started automatically after bus or mains voltage return. The staircase function must be enabled.

- Set the parameter "Behaviour after bus or mains voltage return" on parameter page "Ax – General" to "activate staircase function".
The staircase time of the staircase function is started immediately after bus or mains voltage return.

- ❗ For this setting it is indispensable that the staircase function has been programmed and enabled beforehand. If the staircase function has not been enabled, this setting will produce no reaction after return of bus/mains voltage.
- ❗ The parameterized behaviour will only be executed, if no forced-control function is active after bus voltage return.

Scene function

Up to 8 scenes can be created and the corresponding scene values stored in the actuator separately for each output. The scene values are recalled or stored via a separate scene extension object by means of extension telegrams. The datapoint type of the extension object permits addressing of up to 64 scenes max. For this reason, the scene number (1...64) with which the internal scene (1...8) is addressed can be determined in the parameterization of a scene.

The scene function must have been enabled on parameter page "Ax – Enabled functions" separately for each output before the required communication objects and parameters (on parameter page "Ax – Scenes") are visible.

The scene function can be combined with other functions of the output (cf. fig. 20). In this case, the brightness level last received or adjusted is always executed:

A telegram to the "Switching", "Dimming" or "Brightness value" objects, a scene recall or a scene storage telegram at the time of an active staircase function ends the staircase time prematurely and sets the output to the brightness level corresponding to the object (time delays taken into account) or the scene value received. Similarly, the brightness level of the output set by the "Switching", "Dimming" or "Brightness value" objects or by a scene recall can be overridden by a staircase function.

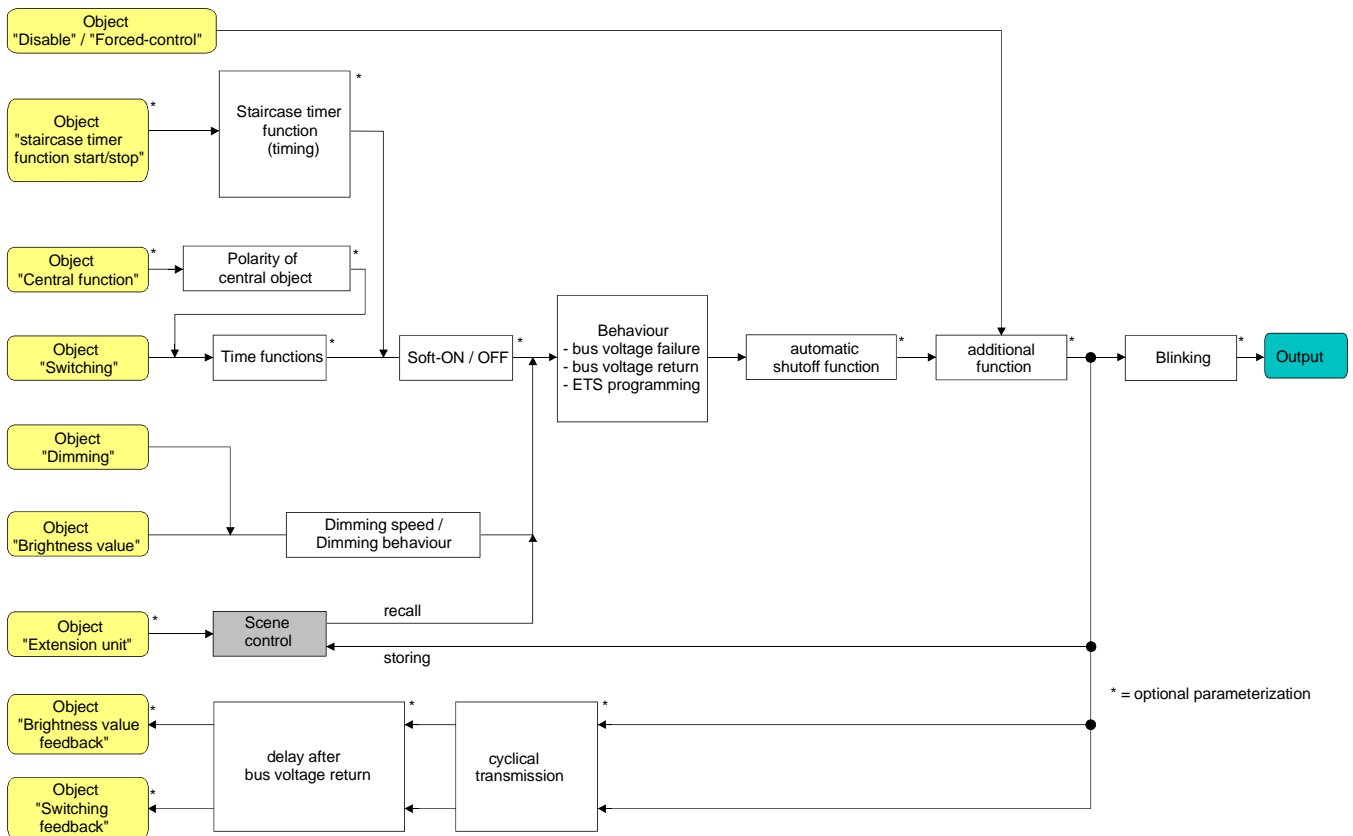

Fig. 20: Functional diagram of the scene function

Presetting a scene recall delay for the scene function

Each scene recall of an output can optionally also be delayed. With this feature, dynamical scene sequences can be configured if several outputs are combined with cyclical scene telegrams.

The scene function must be enabled on parameter page "Ax – Enabled functions (x = number of output 1...4).

- Set the parameter "Delay scene recall ?" on parameter page "Ax – Scenes" to "yes".
The delay time is now activated and can be parameterized separately. The delay only influences the scene recall of the output. The delay time begins on arrival of a recall telegram. The corresponding scene will be recalled and the output set to the respective brightness level only after this time has elapsed.
- ❗ Each scene recall telegram restarts the delay time and retriggers it. If a new scene recall telegram is received while a delay is active (scene recall not yet executed), the old (and not yet recalled scene) will be rejected and only the scene last received executed.
- ❗ The scene recall delay has no influence on the storage of scene values. A scene storage telegram within a scene recall delay terminates the delay and thus the scene recall.

Setting the response to a scene recall

The scene configuration of an output can be used to define whether the actuator recalls scene brightness value by direct or by gradual approach. In case of the gradual approach it is also possible to specify whether a dimming cycle is effected in dimming steps or by fading. A scene recall can thus be effected independently of the preset dimming behaviour and of the dimming characteristics of an output.

The behaviour after a scene recall can be configured separately for each scene.

The scene function must be enabled on parameter page "Ax – Enabled functions (x = number of output 1...4).

- Set the parameter "Response to a scene recall" on parameter page "Ax – Scenes" to "direct jump to brightness value".
The scene brightness values are approached directly in case of recall.
- Set the parameter "Response to a scene recall" on parameter page "Ax – Scenes" to "gradual dimming to brightness value". Define at the same time the required "dimming step time (0...255 ms)" for gradual approach to scene brightness value.
The scene brightness values of the corresponding scene are approached gradually in case of recall. The time in the parameter selection defines the duration of the dimming cycle between 2 of 255 dimming steps.
- Set the parameter "Response to a scene recall" on parameter page "Ax – Scenes" to "gradual dimming to brightness value by fading". Define at the same time the required "fading time (0...240 s)" for gradual approach to scene brightness value.
The scene brightness values of the corresponding scene are approached gradually in case of recall. The dim-fading mode is activated. The time in the parameter selection defines the duration of the dimming cycle until the scene brightness value is reached. The brightness level of an output from which the dimming cycle starts is then of no importance. This means that the dimming cycle in case of scene recall always needs exactly the specified time.

Presetting the ETS download behaviour for the scene function

During storage of a scene, the scene values are stored permanently in the device (cf. "Presetting the storage behaviour for the scene function"). To prevent the stored values from being replaced during application or parameter programming with the ETS by the originally programmed scene brightness levels, the actuator can inhibit overwriting of the scene values. As an alternative, the original values can be reloaded into the device during each ETS programming operation.

The scene function must be enabled on parameter page "Ax – Enabled functions (x = number of output 1...4).

- Set the parameter "Overwrite values stored in the device during download ?" on parameter page "Ax – Scenes" to "yes".

During each application or parameter programming with the ETS, the scene values parameterized in the ETS for the output concerned will be programmed into the actuator. Scene values stored in the device by means of a storage function will be overwritten, if any.

- Set the parameter "Overwrite values stored in the device during download ?" on parameter page "Ax – Scenes" to "yes".

Scene values stored in the device with a storage function will be maintained. If no scene values have been stored, the brightness values last programmed with the ETS remain valid.

- i** When the actuator is put into operation for the first time, this parameter should be set to "yes" so that the output is initialized with valid scene values.

Presetting scene numbers and scene brightness values for the scene function

The datapoint type of the scene extension object permits addressing of up to 64 scenes max. For this reason, the scene number (1...64) with which the scene is addressed, i.e. recalled or stored, must be determined for each internal scene (1...8) of the output. Moreover, the brightness value to be set at the output in case of a scene recall must be specified as well.

The scene function must be enabled on parameter page "Ax – Enabled functions (x = number of output 1...4).

- Set the parameter "Scene x activatable by scene number" (x = number of the scene (1...8)) for each scene on parameter page "Ax – Scenes" to the numbers with which the scenes are to be addressed. A scene can be addressed with the parameterized scene number. A setting of "0" deactivates the corresponding scene so that neither recalling nor storage is possible.

- i** If the same scene number is parameterized for several scenes, only the scene with the lowest internal scene number (1...8) will be addressed. The other internal scenes will be ignored in this case.

- Set the parameter "Brightness value for scene x" (x = number of the scene (1...8)) on parameter page "Ax – Scenes" for each scene to the desired brightness value.
In case of a scene recall, the parameterized brightness value is recalled and the output is set to this value.
- ❗ The parameterized brightness value is adopted by the actuator during programming with the ETS only if the parameter "Overwrite scene values during ETS download" is set to "yes".
- ❗ It must be ensured that the parameterized scene brightness value is below the preset maximum brightness level.

Presetting the storage behaviour for the scene function

The scene brightness value adjusted at the output in accordance with the functional diagram can be stored internally via the extension object – even during the dimming cycle. In this case, the brightness value can be influenced before storage by all functions of the output provided the individual functions have been enabled (e.g. also the disabling function, forced-control function, etc.).

The scene function must be enabled on parameter page "Ax – Enabled functions (x = number of output 1...4).

- Set the parameter "Storage function for scene x" (x = number of the scene (1...8)) on parameter page "Ax – Scenes" for each scene to "yes".
The storage function is activated for the scene in question. On reception of a storage telegram via the "Scene extension" object, the current position value will be internally stored.
- Set the parameter "Storage function for scene x" (x = number of the scene (1...8)) on parameter page "Ax – Scenes" for each scene to "no".
The storage function is deactivated for the scene in question. A storage telegram received via the "Scene extension" object will be rejected.

Operating hours counter

The operating hours counter tracks the ON-time of a dimming output. For the operating hours counter an output is actively on, when the brightness value is greater than "0", i.e. when current is flowing into the load.

The operating hours counter sums up the determined ON-time for a closed relay contact precise to the minute rounding the times off to full hours (cf. fig. 21). The accumulated operating hours are tracked in a 2-byte counter and stored permanently in the device. The current count can be transmitted cyclically or after a change by a counting interval to the bus via the communication object "Value operating hours counter".

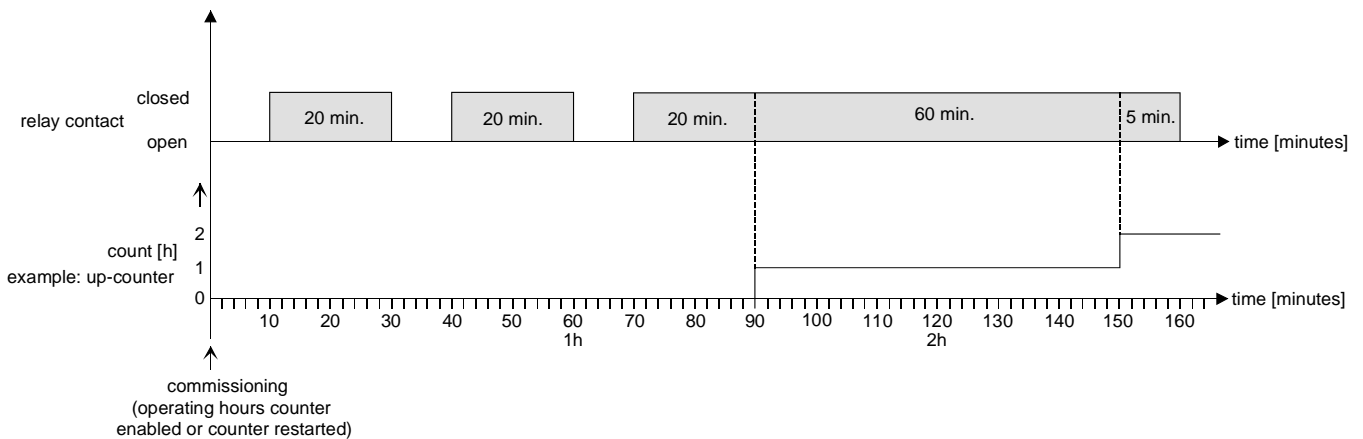

Fig. 21: Functional principle of the operating hours counter

In the as-supplied state, the operating hours count for all outputs of the actuator is "0". If the operating hours counter has not been enabled in the parameters of the output concerned, no operating hours will be counted for the output in question. If enabled, the operating hours counter begins counting and summing up the operating hours immediately after commissioning of the actuator with the ETS.

If an operating hours counter is later on again disabled in the parameters and if the actuator is then programmed with the counter disabled, all operating hours counted beforehand for the output concerned will be deleted. After re-enabling, the operating hours counter always begins with "0".

The operating hours stored in the device (full hours) are not lost after a bus voltage failure or after programming with the ETS. Accumulated operating minutes (full hour not yet reached) are, however, discarded in this case.

After bus / mains voltage return or an ETS download the actuator passively updates the communication object "Value operating hours counter" for each output. The object value can be read out, if the Read flag is set. Depending on the automatic transmission parameters, the object value, if any, is actively transmitted to the bus as soon as the parameterized transmit delay after bus voltage return has elapsed (cf. "Presetting the transmission behaviour of the operating hours counter").

Any operation of the outputs by manual control is detected by the operating hours counter with the result that the activation of an output will start an operating hours count and that the deactivation of this output will stop the count.

No operating hours will be counted if the mains voltage supply of the actuator or of individual load outputs is off.

Activating the operating hours counter

- Set the parameter "Operating hours counter" on parameter page "Ax – Enabled functions" to "enabled".

The operating hours counter is activated.

Deactivating the operating hours counter

- Set the parameter "Operating hours counter" on parameter page "Ax – Enabled functions" to "disabled".

The operating hours counter is deactivated.

- ⓘ Disabling of the operating hours counter and subsequent programming with the ETS causes the counter to be reset to "0".

Presetting the Type of counter of the operating hours counter

The operating hours counter can be configured as an up-counter or a down-counter. Depending on the above mode, the counter permits presetting a limit or starting value which can be used, for instance, to monitor the hours in operation of a lamp by restricting the counting range.

UP-counter:

After activation of the operating hours counter by enabling it in the ETS or by a restart, the operating hours will be counted started from "0". The maximum counting capacity is 65535 hours. Thereafter, the counter stops and reports reaching the maximum count via the "Runout operating hours counter" object .

As an option, a limit value can be preset either in the ETS or via the communication object "Limit value perating hours counter". In this case, the counting status is reported to the bus via the "End-of-counting" object already when the limit value is reached. If not restarted, the counter will nevertheless continue counting until the max. capacity of 65535 hours is reached and stop thereafter. A new count begins only after the counter is restarted.

DOWN-counter:

After enabling the operating hours counter in the ETS, the count is "0" and the actuator reports for the output concerned after programming or after a bus voltage return via the "Runout operating hours counter" object that the counter is running. Only after a restart will the DOWN-counter be preset to the max. value of 65535 and the counting operation be started.

As an option, a start value can be preset either in the ETS or via the communication object "Start value operating hours counter ". If a start value has been preset, the DOWN-counter will be initialized after a restart with this value instead of the max. value. The counter will then decrement the hours beginning with the start value. When the DOWN-counter has reached "0", the counting status is reported to the bus via the "Runout operating hours counter" object and counting is stopped. A new count begins only after the counter is restarted.

The operating hours counter must have been enabled on parameter page "Ax – Enabled functions (x = number of output 1...4).

- Set the parameter "Type of counter" on parameter page "Ax - Operating hours counter" (x = number of output 1...4) to "Up-counter". If limit value monitoring is desired, set the parameter "Limit value preset ?" to "yes, as specified in parameter" or to "yes, as received via object". In all other cases, set the parameter to "no". In the "yes, as specified in parameter" setting, specify the required limit value (1...65535 h).

The counter increments the operating hours beginning with "0". If the limit value monitoring function is active, the actuator sends a "1" telegram for the output concerned via the "End-of-counting" object as soon as the preset limit value is reached. Otherwise, the counter status will be transmitted only after reaching the max. value of 65535.

- Set the parameter "Type of counter" on parameter page "Ax - Operating hours counter" (x = number of output 1...4) to "Down-counter". If a start value preset is required, set the parameter "Start value preset ?" to "Yes, as specified in parameter" or to "Yes, as received via object". In all other cases, set the parameter to "no". In the "yes, as specified in parameter" setting, specify the required start value (1...65535 h).

After a restart, the counter decrements the operating hours until "0" is reached. If the start value preset mode is active, the counter counts down from the start value. Otherwise, counting begins from the max. value 65535. The actuator sends a "1" telegram for the output concerned via the object "Runout operating hours counter" as soon as "0" is reached.

- ❗ The value of the communication object "Runout operating hours counter" is stored internally in a non-volatile memory. After bus / mains voltage return or after an ETS programming operation, the object will be re-initialized with the previously stored value. If an operating hours counter is identified as run out in this case, i.e. if the object value is a "1", an additional telegram will be actively transmitted to the bus as soon as the parameterized transmit delay has elapsed after bus voltage return. If the counter has not yet run out (object value "0"), then no telegram will be sent after bus / mains voltage return or after an ETS programming operation.
- ❗ In case of limit or start value preset via an object: The values received via the object will be adopted as valid only after a restart of the operating hours counter and stored internally in a non-volatile memory. After bus / mains voltage return or after an ETS programming operation, the object will be initialized with the value last stored. The values received are lost during a bus / mains voltage failure or an ETS download, if the counter has not been restarted beforehand. For this reason, it is recommended to always restart the counter whenever a new start or limit value is being preset. As long as no limit or start value has been received via the object, a fixed standard value of 65535 is the default. The values received via the object and stored will be reset to the default value, if the operating hours counter is disabled in the parameters of the ETS and if an ETS download is made.
- ❗ In case of limit or start value preset via an object: If the start or limit value is preset as "0", the actuator ignores a counter restart in order to avoid an undesired reset (e.g. site operation → hours already counted by manual operation).
- ❗ If the counting direction of an operating hours counter is reversed by parameter change in the ETS, the counter should always be restarted after programming of the actuator to ensure its re-initialization.

Restarting the operating hours counter

The operating hours count can be reset at any time by the "New start operating hours counter" communication object. The polarity of the restart telegram object is fixed. 1" = restart / "0" = no reaction.

- Set the communication object "New start operating hours counter" to "1".
In case of an Up-counter, the counter will be initialized during restart with a "0" and in case of a Down-counter with the start value. If no start value has been parameterized or preset via the object, the start value is fixed with 65535.

During each restart of the counter, the initialized count will be transmitted actively to the bus.

During a restart, the 'end-of-counting' message will be reset as well. In this case, a "0" telegram will be transmitted to the bus via the "Runout operating hours counter" object.

In addition, the limit or start value will be initialized as well.

- ❗ If a new limit or start value has been preset via the communication object, the counter should always be restarted thereafter. Otherwise, the received values will be lost during a bus / mains voltage failure or an ETS download.
- ❗ If a start or a limit value is preset with "0", the device will show different reactions during a restart depending on the type of value preset...

Preset like parameter: The counter runs out immediately after a counter restart.

Preset via object:

A counter restart will be ignored to avoid an undesired reset (e.g. after installation of the devices with hours already being counted by manual operation). To perform the restart, it is necessary to preset at first a start or limit value greater than "0".

Presetting the transmission behaviour of the operating hours counter

The current value of the operating hours counter is always tracked in the communication object "Value operating hours counter". After bus / mains voltage return or an ETS download the actuator passively updates the communication object "Value operating hours counter" for each output. The object value can be read out, if the Read flag is set.

In addition, the transmit behaviour of this communication object can be preset.

The operating hours counter must have been enabled on parameter page "Ax – Enabled functions (x = number of output 1...4).

- Set the parameter "Automatic transmission of counting value" on parameter page "Ax – Operating hours counter" (x = number of output) to "after change by interval value". Set the parameter "Counting value interval (1..65535)" to the desired value.

The count is transmitted to the bus as soon as it changes by the preset Counting value interval. After bus / mains voltage return or after an ETS programming operation, the object value will be automatically transmitted after the "Delay after bus voltage return" has elapsed, when the current count corresponds to the Counting value interval or a multiple thereof. A count of "0" will in this case always be transmitted.

- Set the parameter "Automatic transmission of counting value" on parameter page "Ax – Operating hours counter" (x = number of output) to "cyclical".

The counter value is transmitted cyclically. The cycle time is defined channel-independent on parameter page "Time settings". After bus / mains voltage return or after programming with the ETS, the count will be transmitted to the bus for the first time after the parameterized cycle time has elapsed.

Supplementary functions

For each dimming output, additional functions can be enabled. As additional function, a disabling function or alternatively a forced-control function can be configured. Only one of these functions can be enabled for an output.

The additional functions are enabled and parameterized on parameter page "Ax - Supplementary functions" (x = number of output 1...4).

Presetting the disabling function as supplementary function

During an active disable, the KNX/EIB bus operation of the output concerned is overridden and interlocked (cf. fig. 22). By overriding the output it is possible to implement a permanent lighting function.

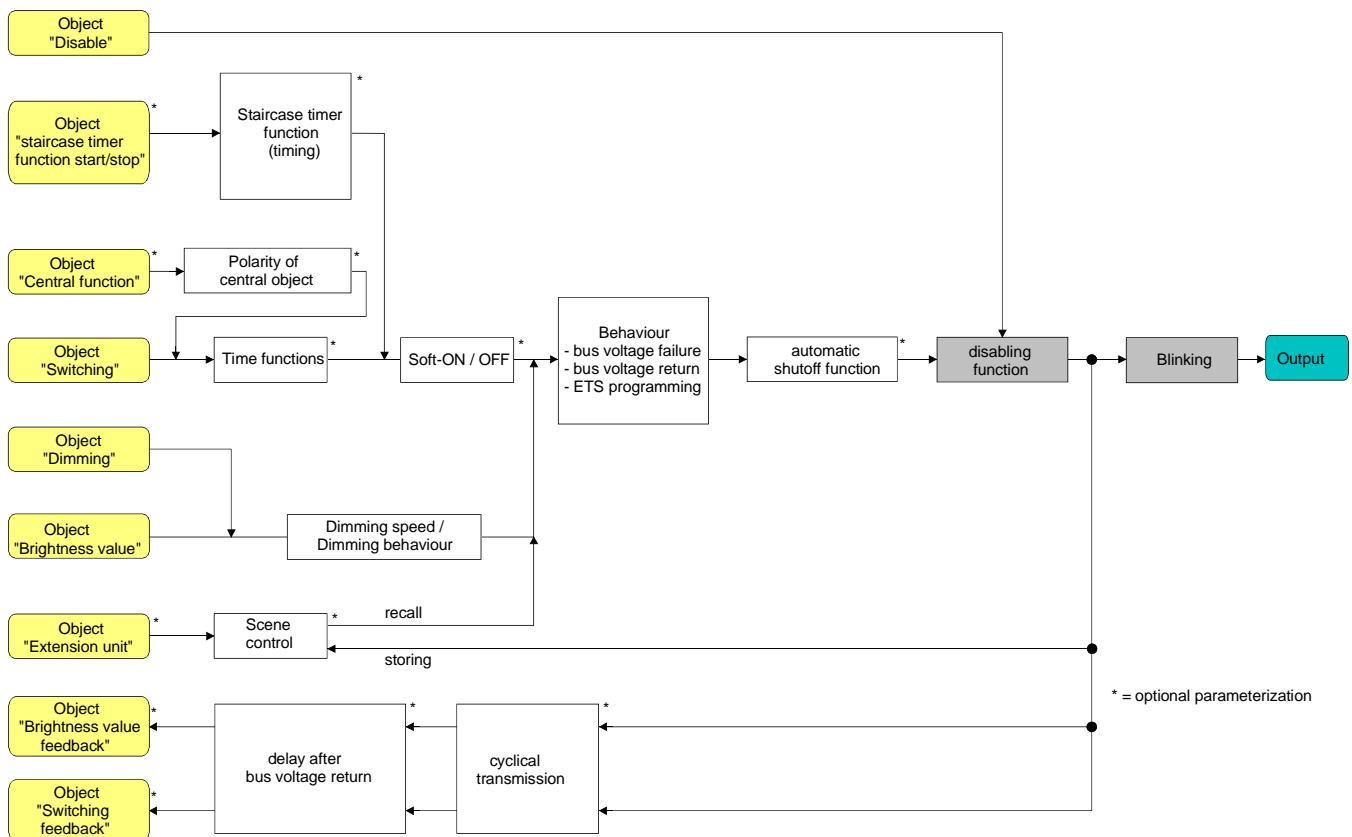

Fig. 22: Functional diagram of the disabling function

- Set the parameter "Selection of supplementary function" on parameter page "Ax – Supplementary functions" (x = number of output 1...4) to "disabling function".
The disabling function is enabled. The "Disabling" communication object and the parameters of the disabling function are visible.
- Set the parameter "Polarity of disable object" on parameter page "Ax – Supplementary functions" to the desired polarity.

- Set the parameter "Behaviour at the beginning of the disabling function" on parameter page "Ax – Supplementary functions" to the desired behaviour.

At the beginning of disabling, the parameterized behaviour will be executed and bus control of the output interlocked. In the "no reaction" setting, the output shows no reaction and remains at the brightness level last adjusted.

When "blinking" is selected, the output is switched on and off cyclically during disable. The blinking rate is generally parameterized for all outputs on parameter page "General". During the blinking interval, the logic switching state of the output is reported back as "switched on - 1" and the brightness value as "switch-on brightness". Soft-ON / soft-OFF functions, if any, will not be executed during the blinking interval.

If the parameter is set to "memory value", the output is adjusted to the brightness value that was active and internally stored before the last shut-off (via the "Switching" or the "Central function" object). This memory value is stored non-permanently which means that this value preset to maximum brightness after a mains voltage return or after an ETS programming operation. A bus voltage failure alone is not sufficient to delete the memory value.
 - Set the parameter "Behaviour at the end of the disabling function" on parameter page "Ax – Supplementary functions" to the desired behaviour.

At the end of disabling, the parameterized behaviour will be executed and bus control of the output re-enabled. In the "no reaction" setting, the output shows no reaction and remains at the brightness level last adjusted by the disabling function.

In the "tracked brightness value" setting, the state received during the disabling function or the state adjusted before the disabling function will be tracked at the end of disable the corresponding brightness level. Running time functions, if any, will also be considered.

When "blinking" is selected, the output is switched on and off cyclically after disabling. The blinking rate is generally parameterized for all outputs on the "General" parameter page. During the blinking interval, the logic switching state of the output is reported back as "switched on - 1" and the brightness value as "switch-on brightness". Soft-ON / soft-OFF functions, if any, will not be executed during the blinking interval. The blinking state remains active until another bus command with another brightness state is being received.

If the parameter is set to "memory value", the output is adjusted to the brightness value that was active and internally stored before the last shut-off (via the "Switching" or the "Central function" object). This memory value is stored non-permanently which means that this value preset to maximum brightness after a mains voltage return or after an ETS programming operation. A bus voltage failure alone is not sufficient to delete the memory value.
- ❗ If a brightness value is parameterized for the beginning and for the end of the disabling function, the selected value must not exceed the maximum brightness preset in the ETS!
 - ❗ After a bus or a mains voltage failure or after programming of the application or of the parameters with the ETS, the disabling function is always deactivated (object value "0"). In the inverted setting ("1 = enabled; 0 = disabled"), a "0" telegram update must first be sent after the initialization before the disabled state is activated.
 - ❗ Updates of the disabling object from "activated" to "activated" or from "deactivated" to "deactivated" show no reaction.
 - ❗ An output disabled via the KNX/EIB can nevertheless be operated by hand! At the end of a manual control cycle, the actuator re-executes the disabling function for the output concerned if the disabling function is still activated at this time.
 - ❗ In case of the "tracked brightness value" setting: During disabling, the overridden functions of the actuator (switching, dimming, brightness value, scenes) continue to be processed internally. This means that all newly received bus telegrams will be evaluated and that time functions will be triggered. At the end of disabling, the states thus tracked will be taken over.

Presetting the forced-control function as supplementary function

As can be seen from the functional diagram (cf. fig. 23), the forced-control function can also be combined with other output functions. In case of an active forced-control function, the preceding functions are overridden so that the output concerned will be interlocked.

The forced-control function has a separate 2-bit communication object of its own. The first bit (bit 0) of the "Forced-control position" object determines whether the output is switched off or on by Forced-control position. In the case of forced-control switch-on, an ETS parameter determines the brightness level with which the lights are switched on. The second bit (bit 1) activates or deactivates the forced-control state (cf. table 2).

The behaviour of an output at the end of the forced-control function can be parameterized. The forced-control object can moreover be initialized on return of bus voltage.

Bit 1	Bit 0	Function
0	X	Forced-control position not active ⇒ normal control
0	X	Forced-control position not active ⇒ normal control
1	0	Forced-control position active: switching off
1	1	Forced-control position active: switching on with predefined brightness

Table 2: Forced-control position bit coding

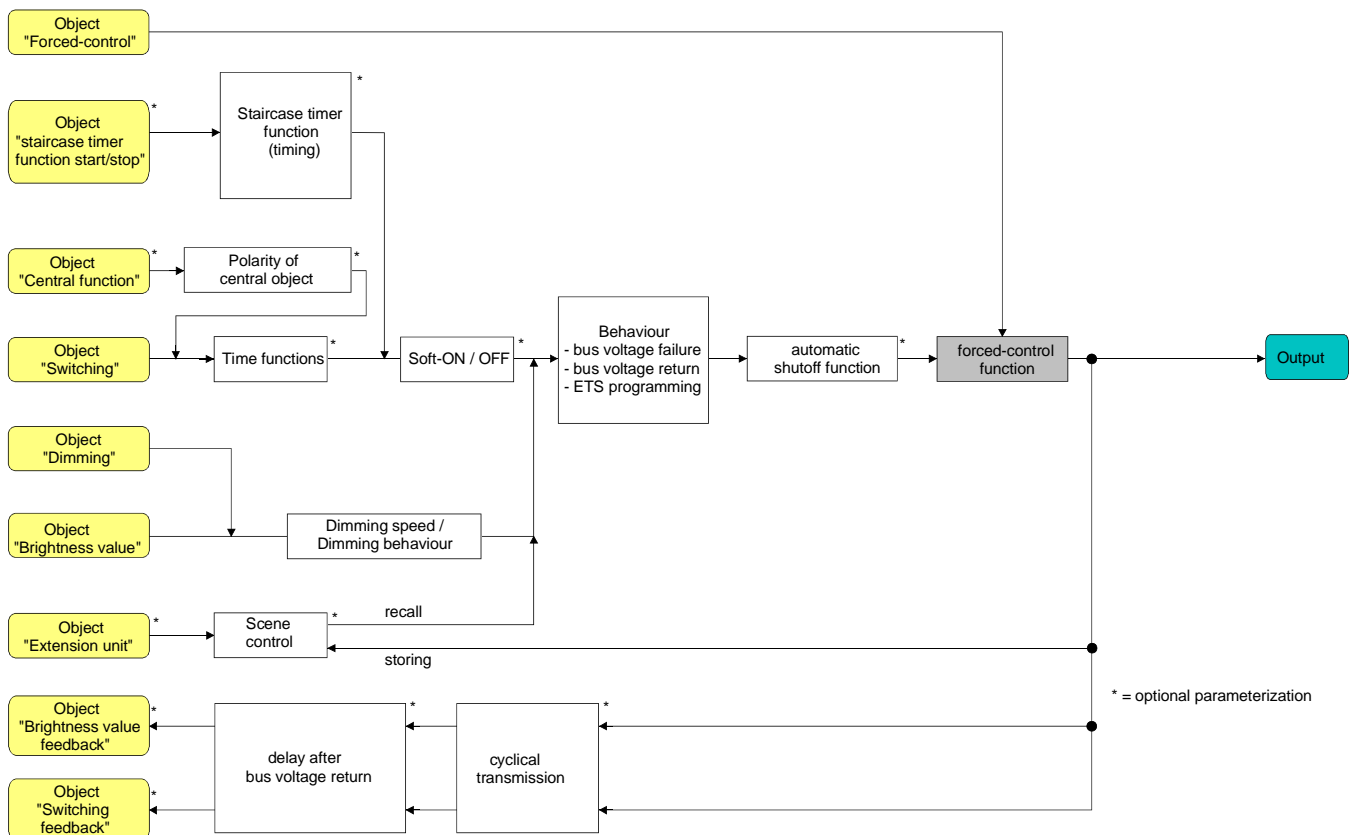

Fig. 23: Functional diagram of the forced-control function

- Set the parameter "Selection of supplementary function" on parameter page "Ax – Supplementary functions" to "Forced-control position".

The forced-control function is enabled. The "Forced-control position" communication object and the parameters of the forced-control function are visible.
 - Set the parameter "Brightness for forced-control position active, ON" on parameter page "Ax - Supplementary functions" to the desired reaction, when a Forced-control position is activated via the communication object.

If a brightness value has been preset, the output is adjusted to this brightness in a forced-control situation. The selected forced-control brightness must not exceed the maximum brightness parameterized in the ETS!
In the "no reaction" setting, the bus control of the output is interlocked, but the output shows no reaction and remains at the brightness level last adjusted.
If the parameter is set to "memory value", the output is adjusted to the brightness value that was active and internally stored before the last shut-off (via the "Switching" or the "Central function" object). This memory value is stored non-permanently which means that this value preset to maximum brightness after a mains voltage return or after an ETS programming operation. A bus voltage failure alone is not sufficient to delete the memory value.
 - Set the parameter "Response at the end of the forced-control position function" on parameter page "Ax – Supplementary functions" to the desired behaviour.

At the end of Forced-control position, the parameterized behaviour will be executed and bus control of the output re-enabled. In the "no reaction" setting, the output shows no reaction and remains at the brightness level last adjusted by Forced-control position.
In the "tracked brightness value" setting, the brightness value received during the disabling function or the value adjusted before the disabling function will be tracked at the end of the forced-control state. Running time functions, if any, will also be considered.
- ⓘ The "Brightness for forced-control position 'active, OFF'" is set invariably to "switching off".
 - ⓘ Updates of the forced-control object from "forced-control active" to "forced-control active" while maintaining the forced switching status or from "forced-control inactive" to "forced-control inactive" show no reaction.
 - ⓘ An output disabled via the KNX/EIB can nevertheless be operated by hand! At the end of a manual control cycle, the actuator re-executes the force-control position function for the output concerned if Forced-control position is still activated at this time.
 - ⓘ In case of the "tracked brightness value" setting at the end of Forced-control position: During Forced-control position, the overridden functions of the actuator (switching, dimming, brightness value, scenes) continue to be processed internally. This means that all newly received bus telegrams will be evaluated and that time functions will be triggered. At the end of Forced-control position, the states thus tracked will be taken over.
 - ⓘ The current state of the force-control position object will be stored in case of bus or mains voltage failure.

- Set the parameter "Behaviour after bus voltage return" on parameter page "Ax – Supplementary functions" to the desired behaviour.

After bus voltage return, the parameterized state is adopted in the "Forced-control position" communication object. In case of active forcing, the output will be switched immediately after bus voltage return to the corresponding state and interlocked by forced-control position until forcing is released via the bus. The parameter "Behaviour after bus / mains voltage return" on parameter page "Ax - General" will in this case not be evaluated for the output concerned.

If the "state of forced-control as before bus voltage failure" setting is selected, the forced-control state last adjusted and internally stored before bus or mains voltage failure will be tracked after bus voltage return. An ETS programming operation deletes the stored state (reaction in that case same as with "no Forced-control position active").

If the tracked state corresponds to "no Forced-control position", the forced-control-independent parameter "Behaviour after bus / mains voltage return" (parameter page "Ax – General") will be executed on return of bus voltage. In case of active forcing, the output will be switched on with the brightness value defined by the "Brightness for forced-control position 'active, ON'" parameter.

- ❗ On return of mains voltage, the force-control position function is always deactivated.
- ❗ After programming of the application or of the parameters with the ETS, the force-control position function is always deactivated (object value "0").

Dimming characteristics, dimming behaviour and dimming speeds

The brightness of lamps connected to a dimming output can be varied by a dimming procedure. The brightness range that can be used for dimming is defined at the limits by the basic and maximum brightness levels parameterized in the ETS.

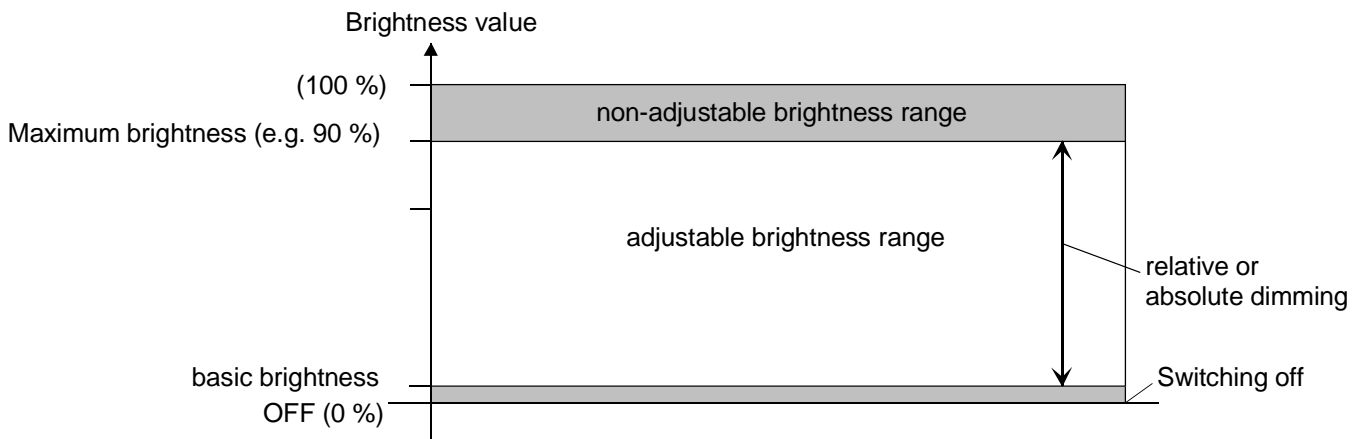

Fig. 24: Usable brightness range for dimming (example)

The brightness of an output can be varied by ...

- relative dimming:
Relative dimming can either be triggered by the 4-bit communication object "Dimming" existing separately for each output or by means of a long key-press in the manual control mode. The data format of the "Dimming" object corresponds to the KNX standardization for DPT "3.007" so that it is possible to preset the dimming direction and relative dimming step times and also to stop dimming procedures in the dimming telegram. In relative dimming by means of a manual control operation locally on the dimming actuator itself, a dimming cycle is executed as long as the corresponding key is depressed. The dimming procedure stops on releasing the key or when the basic or maximum brightness values are reached.
- absolute dimming:
Absolute dimming is triggered by presetting a brightness value. This value can be preset from the KNX/EIB via the 1-byte communication object "Brightness value" existing separately for each output. The presetting of brightness values by a disabling or force-control position function or the scene function is also possible. Absolute dimming by presetting brightness values can also be activated in case of bus voltage failure or on bus/mains voltage return or after an ETS programming operation. In case of presetting the brightness value via the object or by a scene recall, it is possible to program in the ETS whether the brightness value is to be approached directly or – as an alternative – gradually by means of the configured dimming step times or by fading. In all other absolute dimming functions, the set brightness values are always approached directly.

The dimming speed is not the same for relative dimming and for the gradual approach of a preset absolute brightness value (not fading) and can be preset separately for each dimming output in the characteristics parameters of the ETS.

i Even in the direct approach of brightness values, the connected lamps can always be seen performing a very brief dimming cycle. This is also the case for switching without soft-ON or soft-OFF function. This dimming cycle is required for reasons inherent in the system. The directly approached brightness value is reached with the minimum dimming step time of 1 ms. This time cannot be changed.

Configuring the dimming characteristics

In the universal dimming actuator, the full brightness range (basic brightness ... 100 %) is divided into 255 dimming steps (8-bit brightness value: 1...255 / 0 = off) In the as-supplied state of the actuator, the dimming step times, i.e. the dimming times between 2 of the 255 dimming steps are adjusted to the same length. This results in a linear dimming characteristic over the whole brightness range (cf. fig. 25).

The dimmable brightness range is limited at the upper end by the maximum brightness configured in the ETS. The lower limit is given by the basic brightness (brightness value = 1).

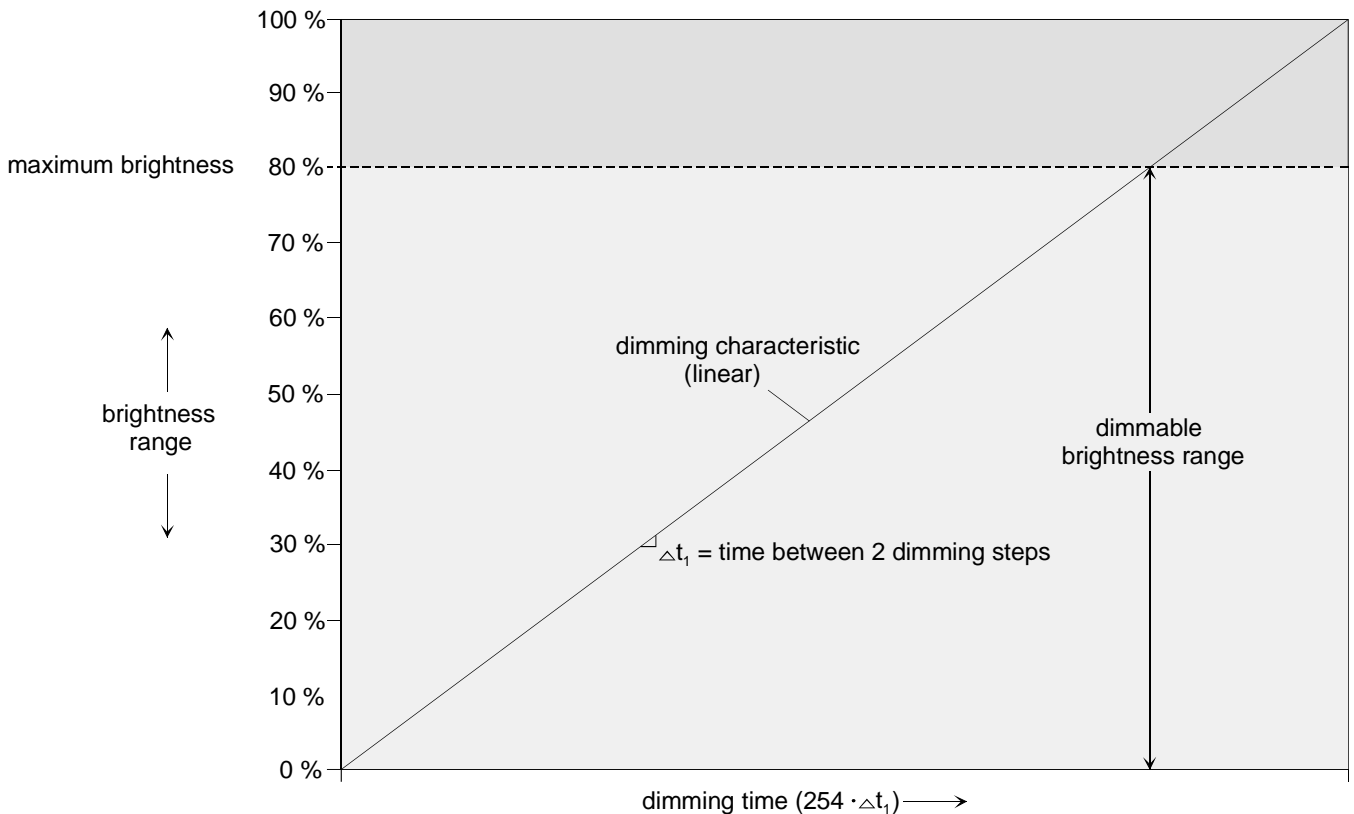

Fig. 25: Example of a linear dimming characteristic with a maximum brightness < 100 %

In some practical applications, a linear dimming characteristic is not optimal. For this reason, the dimming characteristic of the universal dimming actuator can alternatively be adapted in ETS to user requirements. This feature permits adapting the brightness changes during the dimming cycle to the subjective sensation of brightness of the human eye by dividing the brightness range into up to three sub-ranges with different dimming step times (cf. fig. 26).

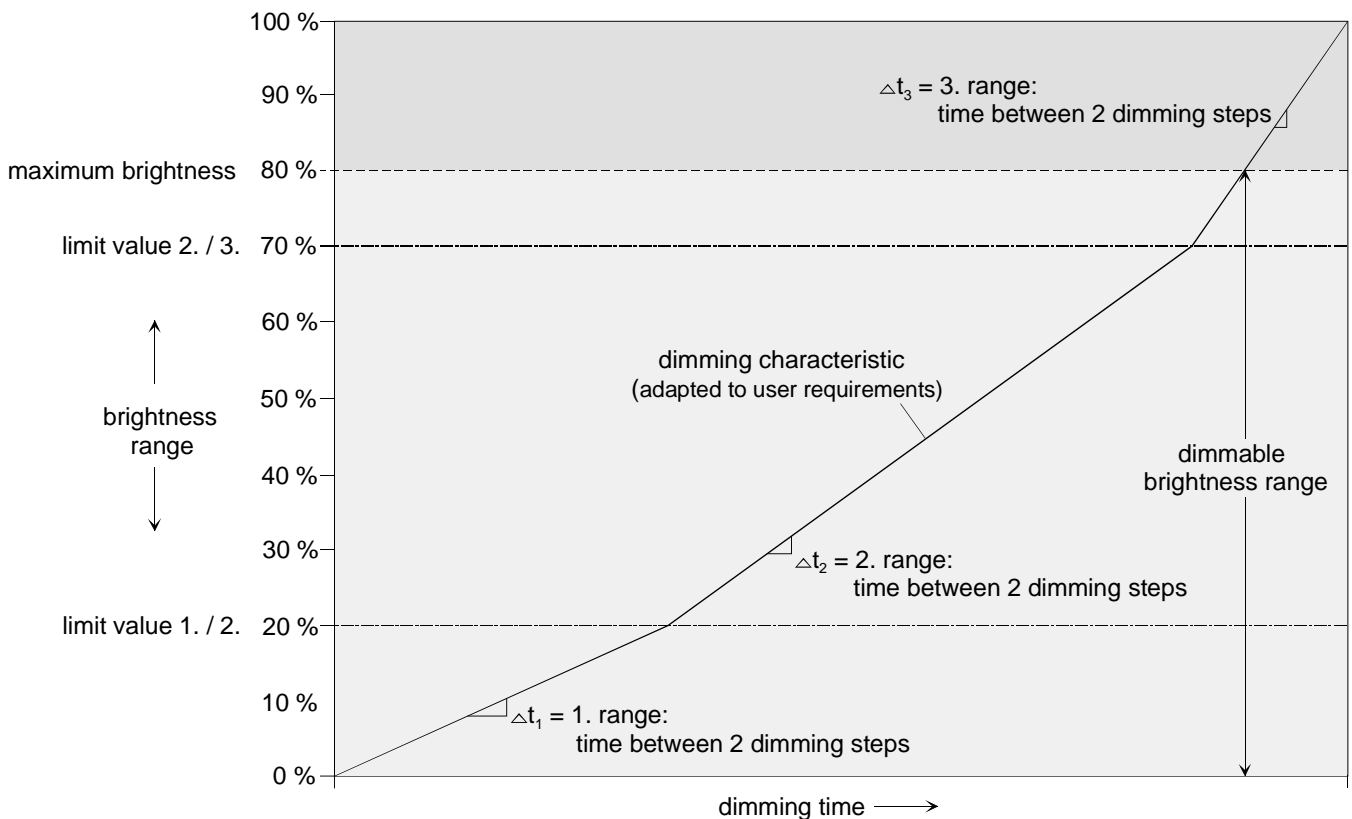

Fig. 26: Example of dimming characteristic adapted to user requirements with three brightness ranges and different dimming step times and maximum brightness < 100 %

A further option permits presetting predefined dimming characteristics for incandescent or for halogen lamps in the corresponding parameters. With this option, the dimming characteristic can be optimized for the mentioned load types without having to parameterize a dimming step time. In this case, the dimming actuator works with fixed predefined brightness sub-ranges and dimming step times.

i General information: An increase of the brightness value in the dimming actuator results in a reduction of the residual phase angle at the dimming output. Similarly, a reduction of the brightness value at the dimming output results in an increase of the residual phase angle. The residual phase angle determines among other things also the dark interval of the connected lamp.

- Set the parameter "Nature of dimming characteristic" on parameter page "Ax - Dimming characteristic" (x = number of output 1...4) to "linear".
The actuator works with a linear dimming characteristic as shown in fig. 25. In addition, a dimming step time for the full brightness range can be configured in the ETS.
- Set the parameter "Nature of dimming characteristic" on parameter page "Ax = Dimming characteristic" to "user-defined".
The actuator works with a user-defined dimming characteristic as shown in fig. 26. In addition, two limit values and three dimming step times for defining three brightness sub-ranges can be preset.
- Set the parameter "Nature of dimming characteristic" on parameter page "Ax = Dimming characteristic" to "adapted to incandescent lamps".
The actuator works with a dimming characteristic specially adapted to incandescent lamps. Further settings for the dimming characteristic are not required.
- Set the parameter "Nature of dimming characteristic" on parameter page "Ax = Dimming characteristic" to "adapted to halogen lamps".
The actuator works with a dimming characteristic specially adapted to halogen lamps. Further settings for the dimming characteristic are not required.

Presetting the dimming step time

The dimming speed is the same for relative dimming and for direct approach of a preset absolute brightness value (not fading) and can be preset separately for each dimming output in the characteristics parameters of the ETS.

Configuration of a dimming step time is only required, if the nature of the characteristic is set to "linear" or "user-defined" (cf. "Configuring the dimming characteristics" above).

The parameter "Nature of dimming characteristic" is set to "linear"

- Set the parameter "Time between two dimming steps" on parameter page "Ax = Dimming characteristic" to the desired dimming step time.
During every relative or absolute dimming cycle, dimming is performed over the whole range of brightness values with the configured dimming step time.

The parameter "Nature of dimming characteristic" is set to "user-defined".

- At first, the brightness limit values must be fixed. Set the parameters "Brightness value limit 1st range / 2nd range (1...100 %)" and "Brightness value limit 2nd range / 3rd range (1...100 %)" on parameter page "Ax = Dimming characteristic" to the required sub-range limits, making sure that the brightness limit value of range 1 / 2 is less than that of range 2 / 3 (cf. fig. 26). Otherwise, risk of malfunction.
The whole brightness range (basic brightness ... 100 %) is divided into three sub-ranges. In the next parameters, the dimming step times can be preset separately for these three ranges.

- Set the parameter "... time between two dimming steps (1...255 ms)" on parameter page "Ax = Dimming characteristic" for each of the three ranges to the desired dimming step times. The dimming characteristic is now completely defined. Dimming is performed in each of the three sub-ranges with the specified dimming step time.

i The dimming step time for scenes with gradual dimming approach to scene values is defined separately in the scene parameters of an output (cf. "Scene function").

Presetting the dimming behaviour for absolute dimming via the "Brightness value" object

The dimming behaviour for absolute dimming via the "Brightness value" object can be preset separately for each output in the ETS.

- Set the parameter "Dimming response to a brightness value" on parameter page "Ax - General" (x = number of output 1...4) to "gradual dimming".
As soon as a new brightness value is received, it will be set with the configured dimming step time (cf. "Configuring the dimming characteristics" and "Presetting the dimming step time" above) and with the predefined dimming characteristic.

- Set the parameter "Dimming response to a brightness value" to "direct jump".
As soon as a new brightness value is received it will be approached directly.

- Set the parameter "Dimming response to a brightness value" to "fading". Define equally the required fading time in the parameter "Time for brightness value via fading" for the gradual approach to the brightness value.

Newly received brightness values are approached gradually. The dim-fading mode is activated. The fading time defines the duration of the dimming cycle until the new brightness value is reached. The brightness level of the output from which the dimming cycle starts and the configured dimming characteristic are of no importance. This means that the dimming cycle always needs exactly the specified time when a new brightness value is preset.

i Brightness values can also be preset by a disabling or by a forced-control position function. Absolute dimming by presetting brightness values can also be activated in case of bus voltage failure or on bus/mains voltage return or after an ETS programming operation. In these absolute dimming functions, the set brightness values are always approached directly. The dimming behaviour for scene recalls can be configured separately (cf. "Scene function").

4.2.4.4 Delivery state

In the as-supplied state, the universal dimming actuator is passive, i.e. no telegrams are transmitted to the bus. The connected loads can, however, be operated by manual control on the device itself, if the mains voltage is on. In the manual control mode, no feedback telegrams are sent to the bus. All other functions of the actuator are deactivated.



The device can be programmed and put into operation with the ETS. The physical address is preset to 15.15.255.

Moreover the device has been configured at the factory with the following data...

- Dimming principle: universal
- Time between two dimming steps in the manual control mode: 12 ms
- Basic brightness: level 5 (standard halogen)
- Maximum brightness: 100 %
- Switch-on brightness: 100 %
- Behaviour after bus voltage failure: no reaction
- Behaviour after bus voltage return: no reaction
- Behaviour after return of the actuator's mains supply: the device performs the automatic load detection procedure. This procedure depends on the conditions prevailing in the supply network and can last up to 10 seconds. Thereafter, all outputs are shut off.
- Operating hours counter: deactivated
- Behaviour at the end of the manual control mode: no change

i The as-supplied state can be restored at any time by unloading the application program with the ETS. In this case, the manual control mode continues to be available.

4.2.5 Parameters

Description:	Values:	Remarks:
 General		
Delay after bus voltage return Minutes (0...59)	0...59	<p>To reduce telegram traffic on the bus line after bus voltage activation (bus reset), after activation of the mains supply, connection of the device to the bus line or after an ETS programming operation, it is possible to delay all active feedbacks of the actuator. The parameter specifies in this case a device-independent delay. Feedback telegrams for initialization will therefore be transmitted to the bus only after the parametrized time has elapsed.</p> <p>Sets the minutes of the delay time.</p>
Seconds (0...59)	0...17...59	<p>Sets the seconds of the delay time.</p> <p><i>Presetting: 17 seconds</i></p>
Central function ?	yes no	<p>Setting "yes" enables the central function and thus the "Central function" object. Individual switching outputs can be assigned to the central function only if the function is enabled</p>
Central object polarity	0 = disabled; 1 = enabled 0 = enabled; 1 = disabled	<p>This parameter defines the polarity of the central object.</p> <p> Only visible if "Central function ? = yes"!</p>

Blinking rate **1 s**
 2 s
 5 s
 10 s

At the beginning and at the end of a disabling function (if used), switching outputs can also be parameterized as "blinking". In this case, the connected lamps change their switching state cyclically.

The "Blinking rate" parameter generally defines the ON-time and the OFF-time of a "blinking" output signal for all outputs.

Example:



Blinking rate = 1 s

1 s on → 1 s off → 1 s on → 1 s off ...

 Time settings

<p>Time for cyclical transmission of feedback telegram Hours (0)..23)</p>	<p>0...23</p>	<p>Depending on parameterization, the different active feedback telegrams of the actuator can transmit their state also cyclically to the bus. The parameter "Time for cyclical transmission of the feedback telegram" generally defines the cycle time for all outputs.</p> <p>Setting the hours of the cycle time.</p>
<p>Minutes (0...59)</p>	<p>0...2...59</p>	<p>Setting the minutes of the cycle time.</p>
<p>Seconds (10...59)</p>	<p>10...59</p>	<p>Setting the seconds of the cycle time.</p> <p><i>Presetting: 2 minutes 10 seconds</i></p>
<p>Time for cyclical transmission operating hours Hours (0...23)</p>	<p>0...23</p>	<p>Depending on parameterization, the operating hours counters of the outputs can also transmit their count cyclically to the bus. The parameter "Time for cyclical transmission of the operating hours" generally defines the cycle time for all outputs.</p> <p>Setting the hours of the cycle time.</p>
<p>Minutes (0...59)</p>	<p>0...59</p>	<p>Setting the minutes of the cycle time.</p>
<p>Seconds (10...59)</p>	<p>10...59</p>	<p>Setting the seconds of the cycle time.</p> <p><i>Presetting: 23 hours 0 minutes 10 seconds</i></p>

 Manual control

Manual control in case of bus voltage failure	disabled enabled	This parameter can be used for programming whether manual control is to be possible (enabled) or deactivated in case of bus voltage failure (bus voltage off).
Manual control during bus operation	disabled enabled	This parameter can be used for programming whether manual control is to be possible (enabled) or deactivated during bus operation (bus voltage on).
Disable function for manual control ?	yes no	Manual control can be disabled via the bus, even if it is already active. For this purpose, the disabling object can be enabled here.
Polarity of disable object for manual control	0 = enabled / 1 = disabled 1 = enabled / 0 = disabled	This parameter defines the polarity of the disabling object.  Only visible if the disabling function for manual control is enabled.  If the setting is "1 = enabled / 0 = disabled", the disabling function is active immediately on return of bus/mains voltage or after an ETS programming operation (object value "0").
Transmit manual control status ?	yes no	The current state of manual control can be transmitted to the bus via a separate status object, if bus voltage is available (setting: "yes").

Function and polarity of
status object

This parameter defines the information
contained in the status object. The object is
always "0", when the manual control mode
is deactivated.

**0 = inactive;
1 = manual control active**

The object is "1" when the manual control
mode is active (temporary or permanent).

0 = inactive;
1 = permanent manual control
active

The object is "1" only when the permanent
manual control is active.

- i** This parameter is visible only if the
manual control status transmission is
enabled.
- i** The status will be actively transmitted to
the bus ("0") after bus voltage return only
if a manual control was terminated by
such return of voltage.

Behaviour at the end of
permanent manual
control during bus mode

The behaviour of the actuator at the end of
permanent manual control depends on this
parameter.

no change

All telegrams received during an active
permanent manual control mode for direct
operation (switching, dimming, brightness
value, scenes) will be discarded. After the
end of the permanent manual control
mode, the current state of all outputs
remains unchanged. If, however, a Forced-
control position or a disabling function was
activated before or during the manual
mode, the dimming actuator does not
execute the reaction parameterized for this
function in the outputs concerned.

track outputs

During an active permanent manual control
all incoming telegrams are internally
tracked. At the end of manual control, the
outputs are adjusted in line with the
command last received or the state existing
before manual control.

 Ax - General (x = 1...4)

Type of connected load		This parameter defines the dimming principle for the output.
	universal (with automatic load detection)	After mains voltage return or after an ETS programming operation, the load is detected automatically. Depending on mains conditions, the detection procedure lasts up to 10 s. With incandescent lamps, the detection procedure is characterized by the lamp flashing twice briefly.
	electronic transformer (capacitive / phase cut-off)	The output is permanently set to the phase cut-off principle. There is no automatic load detection. Only electronic transformers or incandescent lamps may be connected to the outputs.
	conventional transformer (inductive / phase cut-on)	The output is permanently set to the phase cut-on principle. There is no automatic load detection. Only conventional transformers or incandescent lamps may be connected to the outputs.
		 The presetting of a dimming principle, i.e. the parameterization for electronic or inductive transformers, is of interest in case of problems with the automatic detection of the connected load (e.g. when special transformers for universal dimming from some manufacturers are used).
Basic brightness	level 1 level 2 level 3 (incandescent lamps) level 4 level 5 (standard halogen) level 6 level 7 level 8	This parameter is used for presetting the basic brightness (lowest dimming level – brightness value = "1") This feature permits an adaptation to the lamps used and to existing local conditions . Level 1 represents the lowest basic brightness.

Maximum brightness	basic brightness
	5 %
	10 %
	15 %
	20 %
	25 %
	30 %
	35 %
	40 %
	45 %
	50 %
	55 %
	60 %
	65 %
	70 %
	75 %
	80 %
	85 %
	90 %
	95 %
	100 % (maximum brightness)

This parameter defines the maximum brightness of the output. The parameterized value is not exceeded in any state of operation of the dimming actuator during bus control.

i If values exceeding the parameterized maximum brightness are received via the brightness value object or are preset by other functions of the dimming actuator, the actuator adjusts the output concerned to the maximum brightness value.

**Behaviour after ETS
programming**

0 % switching off

The dimming actuator permits setting the brightness value after an ETS programming operation separately for each output.

The output is switched off.

basic brightness

The output is adjusted to the preset brightness value (observe parameterized maximum brightness).

5 %
10 %
15 %
20 %
25 %
30 %
35 %
40 %
45 %
50 %
55 %
60 %
65 %
70 %
75 %
80 %
85 %
90 %
95 %
100 %**no reaction**

After an ETS programming operation, the output shows no reaction and remains at the currently adjusted brightness level or off.

i The behaviour specified in this parameter will be executed after each download of applications or parameters with the ETS. A simple download of the physical address alone or partial programming of only the group addresses has the effect that this parameter is disregarded and that the parameterized "Behaviour after bus or mains voltage return" will be executed instead.

i The parameterized behaviour will only be executed, if the mains voltage supply of the dimming actuator is on at the end of the programming operation.

Behaviour in case of bus
voltage failure

The dimming actuator permits setting the
brightness value in case of bus voltage
failure separately for each output.

0 % switching off

The output is switched off.

basic brightness

The output is adjusted to the preset
brightness value (observe parameterized
maximum brightness!).

- 5 %
- 10 %
- 15 %
- 20 %
- 25 %
- 30 %
- 35 %
- 40 %
- 45 %
- 50 %
- 55 %
- 60 %
- 65 %
- 70 %
- 75 %
- 80 %
- 85 %
- 90 %
- 95 %
- 100 %

no reaction

In case of bus voltage failure, the output
shows no reaction and remains at the
currently adjusted brightness level or off.

Behaviour after bus or
mains voltage return

0 % switching off

The dimming actuator permits setting the brightness value after bus voltage return separately for each output.

The output is switched off.

basic brightness
5 %...100 %

The output is adjusted to the preset brightness value (observe parameterized maximum brightness!).

**brightness value before bus
/ mains voltage failure**

After bus or mains voltage return, the brightness value last adjusted and internally stored before bus or mains voltage failure will be restored.

no reaction

After bus/mains voltage return, the output shows no reaction and remains at the currently adjusted brightness level or off.

activate staircase function

The Staircase function is activated after bus or mains voltage return independent of the "Switching" object. For this setting it is indispensable that the Staircase function has been enabled beforehand. If the Staircase function has not been enabled, this setting will produce no reaction after return of bus/mains voltage.

i Setting "brightness value before bus voltage failure": For restoring the brightness value before bus / mains voltage failure, the brightness values are stored permanently. Storage is only effected, if bus and mains voltage are present and if the mains voltage has been on for at least 20 s. Programming of an application or of parameters with ETS resets the internally stored switching state to "off – 0".

i Note that a forced-control position affecting the brightness level of an output may be active after bus voltage return.

Switch-on brightness

This parameter defines the brightness adjusted at the output after each switch-on via the "Switching" or the "Central function" object.

basic brightness

5 %
10 %
15 %
20 %
25 %
30 %
35 %
40 %
45 %
50 %
55 %
60 %
65 %
70 %
75 %
80 %
85 %
90 %
95 %
100 %

After switch-on, the output is adjusted to the preset brightness value (observe parameterized maximum brightness!).

memory value (brightness prior th the last shut-off)

After switch-on, the output is adjusted to the brightness value that was active and internally stored before the last shut-off (via the "Switching" object. This memory value is stored non-permanently which means that after a mains voltage return or after an ETS programming operation the memory value is identical to the value of maximum brightness.

i If no soft-ON function is active, the output jumps to the brightness value after switch-on (direct approach).

Dimming response to a brightness value	direct jump gradual dimming fading	This parameter defines whether a brightness value received via the bus (absolute dimming) is reached by direct approach or by gradual approach in line with the predefined dimming characteristic. Fading is available as an alternative mode. In the fading mode, the received brightness value is reached in exactly the parameterized time independently of the dimming characteristic and irrespective of the brightness level from which the dimming cycle was started. Several dimming outputs can thus be adjusted in such a way that they all reach the same brightness level at the same time.
Time for brightness value via fading seconds (0...59)	0... 20 ...59	<p>This parameter defines the fading time. A dimming cycle in the fading mode lasts exactly as long as specified in the parameter.</p> <p>A parameter setting of "0" causes the output to jump to the brightness value (direct approach).</p> <p><i>Presetting: 20 seconds</i></p> <p>i Only visible if "Dimming response to a brightness value = fading"</p>
Assignment to central function ?	yes no	<p>This parameter determines the assignment of the output to the central function.</p> <p>The output is assigned to the central function.</p> <p>The output is not assigned to the central function.</p> <p>i This parameter is visible only if the central function is enabled.</p>

 Ax – Enabled functions (x = 1...4)

Feedback telegrams	disabled enabled	This parameter can be used to disable or to enable the feedback functions. When the functions are enabled, the required parameters are displayed under "Ax – Feedbacks".
Time delays	disabled enabled	This parameter can be used disable or to enable the time delays. When the function is enabled, the required parameters will be displayed under "Ax - Time delays
Staircase function	disabled enabled	This parameter can be used disable or to enable the Staircase function. When the function is enabled, the corresponding parameters will be displayed under "Ax - Staircase function" and the necessary objects enabled.
ON/OFF switching behaviour	disabled enabled	This parameter can be used to enable or to disable the functions influencing the switch-on/shut-off behaviour of the output. If the functions are enabled, the required parameters are displayed under "Ax – ON/OFF switching behaviour".
Scene function	disabled enabled	This parameter can be used disable or to enable the scene function. When the function is enabled, the corresponding parameters will be displayed under "Ax - Scenes" and the necessary objects enabled.
Operating hours counter	disabled enabled	This parameter can be used to disable or to enable the operating hours counter. When the function is enabled, the corresponding parameters will be displayed under "Ax - Operating hours counter" and the necessary object enabled.  Disabling of the operating hours counter results in the deletion of any operating hours counted before for the output concerned!

Report short-circuit / overload ?	yes no	This parameter can be used to enable the short-circuit and overload warning messages. After enabling, the corresponding communication object is displayed.
Report load failure ?	yes no	This parameter can be used to enable the load failure warning message. After enabling, the corresponding communication object is displayed.
Report load type ?	yes no	This parameter can be used to enable the load type information message. After enabling, the corresponding communication object is displayed.

 Ax – Feedbacks (x = 1...4 / only visible if the parameter "Feedbacks" on parameter page "Ax – Enabled functions" is set to "enabled").

Switching status
feedback ?

The current switching state of the output can be reported back separately to the bus.

no feedback

No feedback object available for the output. Feedback deactivated.

feedback object is active
message object

Feedback and object are activated. The state is transmitted in non-inverted form. The object transmits actively (telegram transmission after change).

feedback object is passive
status object

Feedback and object are activated. The state is transmitted in non-inverted form. The object is passive (telegram transmission only as a response to 'Read' request).

 The communication flags of the object are automatically set by the ETS according to the setting.

Time delay for feedback telegram after bus voltage return ? **yes**
no

After bus or mains voltage return or after an ETS programming operation, the feedback telegram can be transmitted to the bus with a time delay. Setting "yes" activates the feedback delay. The delay time is parameterized on parameter page "General".

 This parameter is only visible in case of an actively transmitting feedback object.

Cyclical transmission of feedback telegram ?	yes (cyclical transmission and transmission in case of changes)	The object value of the switching status feedback can be transmitted cyclically.
	no (transmission only in case of changes)	The feedback telegram is transmitted to the bus cyclically and after state changes. The cycle time is generally programmed under "Time settings" for all feedback telegrams. The feedback telegram is transmitted to the bus only after updates of the state. i This parameter is only visible in case of an actively transmitting feedback object.
Brightness value feedback ?	no feedback	The current brightness value of the output can be reported back to the bus separately. No feedback object available for the output. Feedback deactivated.
	feedback object is active message object	Feedback and object are activated. The object transmits actively (telegram transmission after change).
	feedback object is passive status object	Feedback and object are activated. The object is passive (telegram transmission only as a response to 'Read' request). i The communication flags of the object are automatically set by the ETS according to the setting.
Time delay for feedback telegram after bus voltage return ?	yes no	After bus or mains voltage return or after an ETS programming operation, the brightness value feedback telegram can be transmitted to the bus with a time delay. Setting "yes" activates the feedback delay. The delay time is parameterized on parameter page "General". i This parameter is only visible in case of an actively transmitting feedback object.

Cyclical transmission of
feedback telegram ?

The object value of the brightness value
feedback can be transmitted cyclically.

yes (cyclical transmission and
transmission in case of
changes)

The feedback telegram is transmitted to the
bus cyclically and after state changes. The
cycle time is generally programmed under
"Time settings" for all feedback telegrams.

**no (transmission only in
case of changes)**

The feedback telegram is transmitted to the
bus only after updates of the state.

This parameter is only visible in case of
an actively transmitting feedback object.

 Ax – Time delays (x = 1...4 / only visible if the parameter "Time delays" on parameter page "Ax – Enabled functions" is set to "enabled").

Selection of time delay	<p>no time delay</p> <p>ON-delay</p> <p>OFF-delay</p> <p>ON-delay and OFF-delay</p>	<p>The "switching" communication object can be evaluated with a time delay. This parameter is used to define the desired mode of operation of the time delay and to enable the other delay parameters.</p>
ON-delay Minutes (0...59)	0...59	<p>This parameter is used for programming the duration of the ON-delay Sets the minutes of the ON-delay.</p>
Seconds (0...59)	0...10...59	<p>Sets the seconds of the ON-delay .</p> <p><i>Presetting: 20 seconds</i></p>
ON-delay retriggerable ?	<p>yes</p> <p>no</p>	<p>An active ON-delay can be retriggered by another "1" telegram (setting "yes"). Alternatively, retriggering can be excluded (setting "no").</p> <p> The ON-delay parameters are only visible when the ON-delay or when ON-delay and OFF-delay are activated.</p>
OFF delay Minutes (0...59)	0...59	<p>This parameter is used for programming the duration of the OFF-delay Sets the minutes of the OFF-delay.</p>
Seconds (0...59)	0...10...59	<p>Sets the minutes of the OFF-delay.</p> <p><i>Presetting: 20 seconds</i></p>

OFF-delay retriggerable yes
? **no**

An active OFF-delay can be retriggered by another "0" telegram (setting "yes"). Alternatively, retriggering can be excluded (setting "no").

i The OFF-delay parameters are only visible when the OFF-delay or when ON-delay and OFF-delay are activated.

 Ax – Staircase function (x = 1...4 / only visible if the parameter "Staircase function" on parameter page "Ax – Enabled functions" is set to "enabled").

Staircase time Hours (0...23) hours (0...23)	0...23	This parameter is used for programming the ON-time of the staircase lighting function. Sets the hours of the staircase lighting ON-time.
Minutes (0...59)	0...5...59	Sets the minutes of the staircase lighting ON-time.
Seconds (0...59)	0...59	Sets the seconds of the staircase lighting ON-time. <i>Presetting: 5 minutes</i>
Staircase time retriggerable ?	yes no	An active ON-time can be retriggered (setting "yes"). Alternatively, retriggering can be excluded (setting "no"). <input type="checkbox"/> This parameter is permanently set to "no", when the additional function "Time extension" is parameterized. In this case, retriggering is not possible.
Response to OFF telegram	switch-off	An active ON-time can be stopped prematurely by deactivating the Staircase function. The ON-time is stopped after reception of an OFF-telegram to the "Staircase function start/stop" object. With the additional function "Time preset via the bus" and parameter "Activate staircase function via the 'Staircase time' object ? = yes", the ON-time can also be terminated prematurely with a factor of "0"
	ignore	OFF-telegrams or factors of "0" will be ignored. The ON-time is executed completely.

Supplementary function for staircase function		The Staircase function can be enlarged by two additional functions to be used alternatively. This parameter enables the desired additional function and activates the necessary parameters or objects.
	no additional function	No supplementary function is enabled.
	time extension	Time extension is activated. This function permits retriggering an activated staircase lighting time n times via the object "Staircase function start/stop".
	time preset via the bus	Time preset via the bus is active. With this supplementary function, the parameterized ON-time can be multiplied with a factor received from the bus and thus dynamically adapted.
Max. time extension	1-fold 2-fold 3-fold 4-fold 5-fold	In case of a time extension (retriggering the time n times via the object "Staircase function start/stop"), the parameterized ON-time will – after having elapsed – be extended at maximum by the value programmed in this parameter. 1-fold extension means that the started staircase time can be automatically retriggered at maximum one more time after elapsing. The lighting time is thus doubled. The other setting options apply analogously. i This parameter is visible only when the supplementary function "Time extension" is active.
Staircase function activatable via object 'Staircase function factor' ?	yes no	In case of time preset via the bus, this parameter can be used to define whether the reception of a new time factor starts the ON-time of the staircase function as well. The object "Staircase function start/stop" is then hidden. When the setting is "no", the ON-time can only be activated via the object "Staircase function start/stop". i This parameter is visible only when the supplementary function "Time preset via the bus" is active.

Activate pre-warning
time ?

When the ON-time of a staircase function has elapsed, the output can activate the pre-warning function (reduction of brightness). The pre-warning function is designed to warn a person in the staircase that the lights will go out shortly.

yes

The pre-warning function is activated.

no

The pre-warning function is deactivated.

Pre-warning time
Minutes (0...59)

0...59

This parameter is used for programming the duration of the pre-warning time. The pre-warning time is added to the ON-time. The lights are on with reduced brightness during the time specified in this parameter. Sets the minutes of the pre-warning time.

Seconds (0...59)

0...**30**...59

Sets the seconds of the pre-warning time.

Presetting: 30 seconds

 This parameter is visible only if the pre-warning time is enabled.

Reduced brightness during pre-warning time (1...100 %) 1 %...**50 %**...100 %

This parameter defines the reduced brightness selected for the pre-warning time.

i When the automatic shut-off function is being used: The reduced brightness of the pre-warning launches the shut-off function when reaching or when falling below the shut-off brightness level.

i This parameter is visible only if the pre-warning time is enabled.



 Ax – Switch-on/switch-off behaviour (x = 1...4 / only visible if the parameter "Switch-on/switch-off behaviour" on parameter page "Ax – Enabled functions" is set to "enabled").

Soft-ON function ?	yes	The soft-ON function is used for slowing down the switch-on reaction of the output. If the function is activated (setting "yes"), a dimming cycle to the switch-on brightness is started on reception of a switch-on telegram via the "Switching" or the "Central function" object.
	no	

Time for dimming step soft-ON Seconds (0...59)	0...59	These parameters set the dimming step time for the soft-ON function. Sets the seconds of the dimming step time for soft-ON.
---	---------------	--

Milliseconds (1...99 x 10)	1...99	Sets the milliseconds of the dimming step time for soft-ON.
-------------------------------	---------------	---

Presetting: 10 milliseconds



-  The soft-ON time cannot be retrIGGERED.
-  The parameters of the soft-ON function are only visible, if the soft-ON function is enabled.

Soft-OFF function ?	yes	The soft-OFF function is used for slowing down the shut-off reaction of the output. If the function is activated (setting "yes"), a dimming cycle to brightness "0 %" is started on reception of a switch-off telegram via the "Switching" or the "Central function" object.
	no	

Time for dimming step soft-OFF Seconds (0...59)	0...59	These parameters set the dimming step time for the soft-OFF function. Sets the seconds of the dimming step time for soft-OFF.
--	---------------	--

Milliseconds (1...99 x 10)	1...99	Sets the milliseconds of the dimming step time for soft-OFF.
-------------------------------	---------------	--

Presetting: 10 milliseconds

-  The soft-OFF time cannot be retrIGGERED.
-  The parameters of the soft-OFF function are only visible, if the soft-OFF function is enabled.

Automatic shutoff when falling below a specified brightness ?	yes no	This parameter can be used for activating the automatic shut-off function for the output. If activated, the connected lamps are switched off completely when the brightness falls below a parameterized brightness at the end of a dimming cycle and, if applicable, after a delay has elapsed.
Shutoff when brightness value smaller	5 % 10 % 15 % 20 % 25 % 30 % 35 % 40 % 45 % 50 % 55 % 60 % 65 % 70 % 75 % 80 % 85 % 90 % 95 % 100 %	This parameter defines the level at which – if the brightness falls below this level – the output is switched off at the end of the dimming cycle and, if applicable, after a programmed delay has elapsed. <input type="checkbox"/> If the shut-off brightness is no longer reached due to a disabling or forced-control position function, the shut-off function is not executed. <input type="checkbox"/> This parameter is visible only if the shut-off function is enabled.
Delay until shutoff Hours (0...23)	0...23	This parameter defines the delay of the shut-off function. When the brightness is below the shut-off level at the end of a dimming cycle, the output is switched on after the time preset in this parameter has elapsed. Sets the hours of the delay time.
Minutes (0...59)	0...59	Sets the minutes of the delay time.
Seconds (0...59)	0...30...59	Sets the seconds of the delay time. <i>Presetting: 30 seconds</i> <input type="checkbox"/> The parameters of the delay time are only visible, if the shut-off function is enabled.



 Ax – Scenes (x = 1...4 / only visible if the parameter "Scenes" on parameter page "Ax – Enabled functions" is set to "enabled").

Delay scene recall ?	yes no	A scene is recalled via the scene extension object. If needed, the scene recall can be made with a delay after reception of a recall telegram (setting: "yes"). The recall is alternatively made immediately on reception of the telegram (setting: "no"). i A recall delay has no influence on the storage of scene values.
Delay time Minutes (0...59) Minutes (0...59)	0...59	This parameter defines the time delay for a scene recall. Sets the minutes of the delay time.
Seconds (0...59)	0... 10 ...59	Sets the seconds of the delay time. <i>Presetting: 10 seconds</i> i The delay time parameters are only visible, if the parameter "Delay scene recall ?" is set to "yes".
Response to a scene recall	direct jump to brightness value gradual dimming to brightness value gradual dimming to brightness value by fading	When a scene is recalled, the output concerned is adjusted to the parameterized or stored scene brightness value. This parameter defines whether the brightness value is reached by direct approach, by gradual approach or by fading. In the fading mode, the brightness to be adjusted is reached in exactly the parameterized time independently of the dimming characteristic and irrespective of the brightness level from which the dimming cycle was started. Several dimming outputs can thus be adjusted in such a way that they all reach the same brightness level at the same time.

Dimming step time (0...255 ms)	0... 5 ...255	<p>Sets the dimming step time for the gradual approach to the brightness value.</p> <p>i This parameter is only visible, if the parameter "Behaviour after a scene recall" is set to "gradual approach to brightness value by dimming step time".</p>
Fading time (0...240 s)	0... 2 ...240	<p>Sets the fading time when the brightness value of a scene is to be reached by fading.</p> <p>i This parameter is only visible, when the parameter "Behaviour after a scene recall" is set to "gradual approach to brightness value by fading".</p>
Overwrite values stored in the device during download ?	yes no	<p>When a scene is stored, the scene value of the output is stored internally in the device. To prevent the stored values from being replaced during ETS programming by the originally programmed scene values, the dimming actuator can inhibit overwriting of the scene values (setting: "no").</p> <p>As an alternative, the original values can be reloaded into the device during each ETS programming operation (setting: "yes").</p>
Scene X activatable by scene number (scene number "0" = scene deactivated) <i>X = depending on the scene (1...8)</i>	<p>1*...64</p> <p>*: <i>The predefined scene number is dependent on the scene (1...8).</i></p>	<p>The actuator distinguishes between up to 8 different scenes which are recalled via the scene extension object or stored. The datapoint type of the extension object, however, permits addressing a maximum of 64 scenes.</p> <p>This parameter defines the scene number (1...64) which is used to address the internal scene (1...8). A setting of "0" deactivates the corresponding scene.</p>



Brightness value for scene X	0 % (switching off) basic brightness	This parameter defines the brightness adjusted when a scene is recalled.
<i>X = depending on the scene (1...8)</i>	5 %	
	10 %	
	15 %	
	20 %	
	25 %	
	30 %	
	35 %	
	40 %	
	45 %	
	50 %	
	55 %	
	60 %	
	65 %	
	70 %	
	75 %	
	80 %	
85 %		
90 %		
95 %		
100 %*		
	<i>*: The preset value is dependent on the scene (1...8).</i>	
Storage function for scene X	yes	Setting "yes" enables the storage function of the scene. If the function is enabled, the current brightness value can be stored internally via the extension object on reception of a storage telegram. If "no" is selected, the storage telegrams are discarded.
<i>X = depending on the scene (1...8)</i>	no	

 Ax – Operating hours counter (x = 1...4 / only visible if the parameter "Operating hours counter" on parameter page "Ax – Enabled functions" is set to "enabled").

Type of counter	<p>up-counter</p> <p>down-counter</p>	<p>The operating hours counter can be configured as an up-counter or as a down-counter. The setting has an influence on the visibility of the other parameters and objects of the operating hours counter.</p>
Limit value preset ?	<p>no</p> <p>yes, as specified in parameter</p> <p>yes, as received via object</p>	<p>If the up-counter is used, a limit value can be optionally preset. This parameter defines whether the limit value can be preset in a separate parameter or individually adapted from the bus by an independent communication object. A setting of "no" deactivates the limit value.</p> <p> This parameter is only visible in the configuration "Counter type = Up-counter".</p>
Limit value (1...65535 h)	1... 65535	<p>This parameter is used for setting the start value of the Up-counter. When this limit is reached, a "1" telegram is transmitted via the "End of counting" object. The counter continues to run until the max. count (65535) is reached and stops.</p> <p> This parameter is only visible, if the parameter "Limit value preset ?" is set to "yes, as specified in parameter".</p>
Start value preset ?	<p>no</p> <p>yes, as specified in parameter</p> <p>yes, as received via object</p>	<p>If the down-counter is used, a start value can be preset as an option. This parameter defines whether the start value can be preset in a separate parameter or individually adapted from the bus by an independent communication object. A setting of "no" deactivates the start value.</p> <p> This parameter is only visible in the configuration "Counter type = Down-counter".</p>

Start value (1...65535 h)	1... 65535	<p>This parameter is used for setting the start value of the Down-counter. After the initialization, the counter begins to decrement the hours from the preset value to "0". After reaching the final value, a "1" telegram is transmitted via the "End of counting" object.</p> <p>i This parameter is only visible, if the parameter "Start value preset ?" is set to "yes, as specified in parameter".</p>
Automatic transmission of counting value ?		<p>The current count of the operating hours counter can be actively transmitted to the bus via the communication object "Value operating hours counter".</p>
	cyclical transmission	<p>The count is transmitted to the bus cyclically and after updating. The cycle time is generally programmed for all outputs on the "Time settings" parameter page.</p>
	after change by interval value	<p>The count is transmitted to the bus only after updating.</p>
Counting value interval (1...65535 h)	1...65535	<p>This parameter is used for setting the counting value interval for automatic transmission. The current count will be transmitted to the bus after the time programmed in this parameter has elapsed.</p> <p>i This parameter is only visible, if the parameter "Limit value preset ?" is set to "yes, as specified in parameter".</p>

 Ax – Supplementary functions (x = 1...4 / only visible if the parameter "Supplementary functions" on parameter page "Ax – Enabled functions" is set to "enabled").

Selection of supplementary function	no supplementary function disabling function forced-control position	This parameter can be used to define and to enable the supplementary function. The disabling function can only be parameterized as an alternative to the forced-control position function.
Polarity of disable object	0 = enabled; 1 = disabled 0 = disabled; 1 = enabled	This parameter defines the polarity of the disabling object.  After bus / mains voltage return or programming of the application or of the parameters with the ETS, the disabling function is always deactivated (object value "0"). In the inverted setting ("0 = enabled; 1 = disabled"), a "0" telegram update must first be sent after the initialization before the disabled state can be activated.  This parameter is visible only if the disabling function is enabled.

Behaviour at the beginning of the disabling function

0 % (switching off)

basic brightness
5 %...100 %

memory value (brightness before last shut-off)

no reaction

blinking

The behaviour of the output at the beginning of the disabling function can be parameterized.

The output is switched off at the beginning of disable and interlocked.

At the beginning of disable, the output is adjusted to the preset brightness value (observe parameterized maximum brightness!) and interlocked.

At the beginning of disable, the output is adjusted to the brightness value that was active and internally stored before the last shut-off (via the "Switching" or the "Central function" object. This memory value is not stored permanently which means that this value preset to maximum brightness after a mains voltage return or after an ETS programming operation.

At the beginning of disable, the output shows no reaction and remains at the currently adjusted brightness level or off. Thereafter, the output is interlocked.

The output is switched on and off during disable and is interlocked during this time. The blinking time is generally parameterized for all outputs on the "General" parameter page. During blinking, the logic switching state is "on - 1" and the brightness reported back is the switch-on brightness. Soft-ON / soft-OFF functions are disregarded during blinking.

i An output disabled via the bus can still be operated by hand on the dimming actuator itself.

i This parameter is visible only if the disabling function is enabled.

Behaviour at the end of
the disabling function

The behaviour of the output at the end of
the disabling function can be
parameterized.

0 % (switching off)

The output is shut off at the end of disable
and then re-enabled.

basic brightness
5 %...100 %

At the end of disable, the output is adjusted
to the preset brightness value (observe
parameterized maximum brightness!) and
re-enabled.

memory value (brightness
before last shut-off)

At the end of disable, the output is adjusted
to the brightness value that was active and
internally stored before the last shut-off (via
the "Switching" or the "Central function"
object. This memory value is not stored
permanently which means that this value
preset to maximum brightness after a
mains voltage return or after an ETS
programming operation.

tracked brightness value

At the end of disable, the state received
during the disabling function or the state
adjusted before the disabling function will
be restored. Running time functions, if any,
will also be considered.

no reaction

At the end of disable, the output shows no
reaction and remains at the currently
adjusted brightness level or off. Thereafter,
bus operation of the output is again
enabled.

blinking

At the end of disable, the output is again
enabled for bus operation and starts
blinking. The blinking time is generally
parameterized for all outputs on the
"General" parameter page. During blinking,
the logic switching state is "on - 1" and the
brightness reported back is the switch-on
brightness. Soft-ON / soft-OFF functions
are disregarded during blinking. The
blinking state remains active until another
bus command presetting another state is
being received.

 This parameter is visible only if the
disabling function is enabled.

Brightness for forced-control position
"active, ON"

basic brightness
5 %...**100 %**

memory value (brightness
before last shut-off)

no reaction

If a forced-control position is activated and if forcing is "ON", this parameter can be used to fix the behaviour of the output.

The output is adjusted to the preset brightness value (observe parameterized maximum brightness!).

The output is adjusted to the brightness value that was active and internally stored before the last shut-off (via the "Switching" or the "Central function" object. This memory value is not stored permanently which means that after a mains voltage return or after an ETS programming operation the memory value is identical to the value of maximum brightness.

The output shows no reaction and remains at the currently adjusted brightness level or off.

 This parameter is visible only if the forced-control position function is enabled.

Brightness for forced-control position
"active, OFF"

0 % (switching off)

If a forced-control position is activated and if forcing is "OFF", the output is always shut off.

This parameter cannot be edited.

 This parameter is visible only if the forced-control position function is enabled.

Response at the end of
the forced-control
position function

no reaction

The behaviour of the output at the end of
the forced-control position function can be
programmed in this parameter.

At the end of forced-control position, the
output shows no reaction and remains at
the currently adjusted brightness level or
off. Thereafter, bus operation of the output
is again enabled.

tracked brightness value

At the end of forced-control position, the
state received during the disabling function
or the state adjusted before the disabling
function will be restored with the
corresponding brightness value. Running
time functions, if any, will also be
considered. Thereafter, bus operation of
the output is again enabled.

i This parameter is visible only if the
forced-control position function is
enabled.

Behaviour after bus
voltage return

The communication object of the forced-control position function can be initialized after bus voltage return. The switching state of the output can be influenced when the forced-control position function is activated.

no forced-control position

No forced-control position activated after bus voltage return.

activate forced-control
position, ON

Forced-control position activated. The output will be switched on with the brightness value defined by the parameter "Brightness for forced-control position active, ON" parameter.

activate forced-control
position, OFF

Forced-control position activated. The output will be shut off by Forced-control position.

state of forced-control as
before bus voltage failure

The state of the forced-control position will be restored on bus voltage return as it was stored permanently at the time of a bus or mains voltage failure. After programming of the application or of the parameters with the ETS, the value is internally set to "not active".

In case of active forcing, the output will be switched on with the brightness value defined by the "Brightness for forced-control position active, ON" parameter.

i After programming of the application or of the parameters with the ETS, the forced-control position is always deleted.

i This parameter is visible only if the forced-control position function is enabled.

 Ax – Dimming characteristic (x = 1...4)

Nature of dimming characteristic

This parameter can be used for setting dimming characteristics of the output. This feature permits adapting the device to the lamps used and to the subjective sensation of brightness by the human eye.

linear

The brightness characteristic between basic brightness and 100 % is linear.

adapted to incandescent lamps

The characteristic is adapted to incandescent lamps.

adapted to halogen lamps

The characteristic is adapted to halogen lamps.

user-defined

The brightness characteristic between basic brightness and 100 % can be adapted to individual requirements. For this purpose, the brightness range is divided into up to three sub-ranges. Each sub-range can be configured with an independent dimming speed.

Time between two dimming steps (1...255 ms)

1...**10**...255

This parameter sets the dimming step speed (time between two brightness values) for a linear characteristic.

 Visible only if "Characteristics = linear"

Range 1
Time between two dimming steps (1...255 ms)

1...**20**...255

This parameter sets the dimming step speed (time between two brightness values) of the first sub-range for user-defined characteristics.

 Visible only if "Characteristics = user-defined"

Brightness value limit 1 st range / 2 nd range (1...100 %)	1... 20 ...100	This parameter defines the first brightness limit value. This limit value fixes the limit between the first and the second sub-range. <input type="checkbox"/> Visible only if "Characteristics = user-defined"
Range 2: Time between two dimming steps (1...255 ms)	1... 10 ...255	This parameter sets the dimming step speed (time between two brightness values) of the second sub-range for user-defined characteristics. <input type="checkbox"/> Visible only if "Characteristics = user-defined"
Brightness value limit 2 nd range / 3 rd range (1...100 %)	1... 80 ...100	This parameter defines the second brightness limit value. This limit value fixes the limit between the second and the third sub-range. <input type="checkbox"/> The brightness value specified must be greater than the first brightness limit value. Otherwise, risk of malfunction. <input type="checkbox"/> Visible only if "Characteristics = user-defined"
Range 3: Time between two dimming steps (1...255 ms)	1... 5 ...255	This parameter sets the dimming step speed (time between two brightness values) of the third sub-range for user-defined characteristics. <input type="checkbox"/> Visible only if "Characteristics = user-defined"